

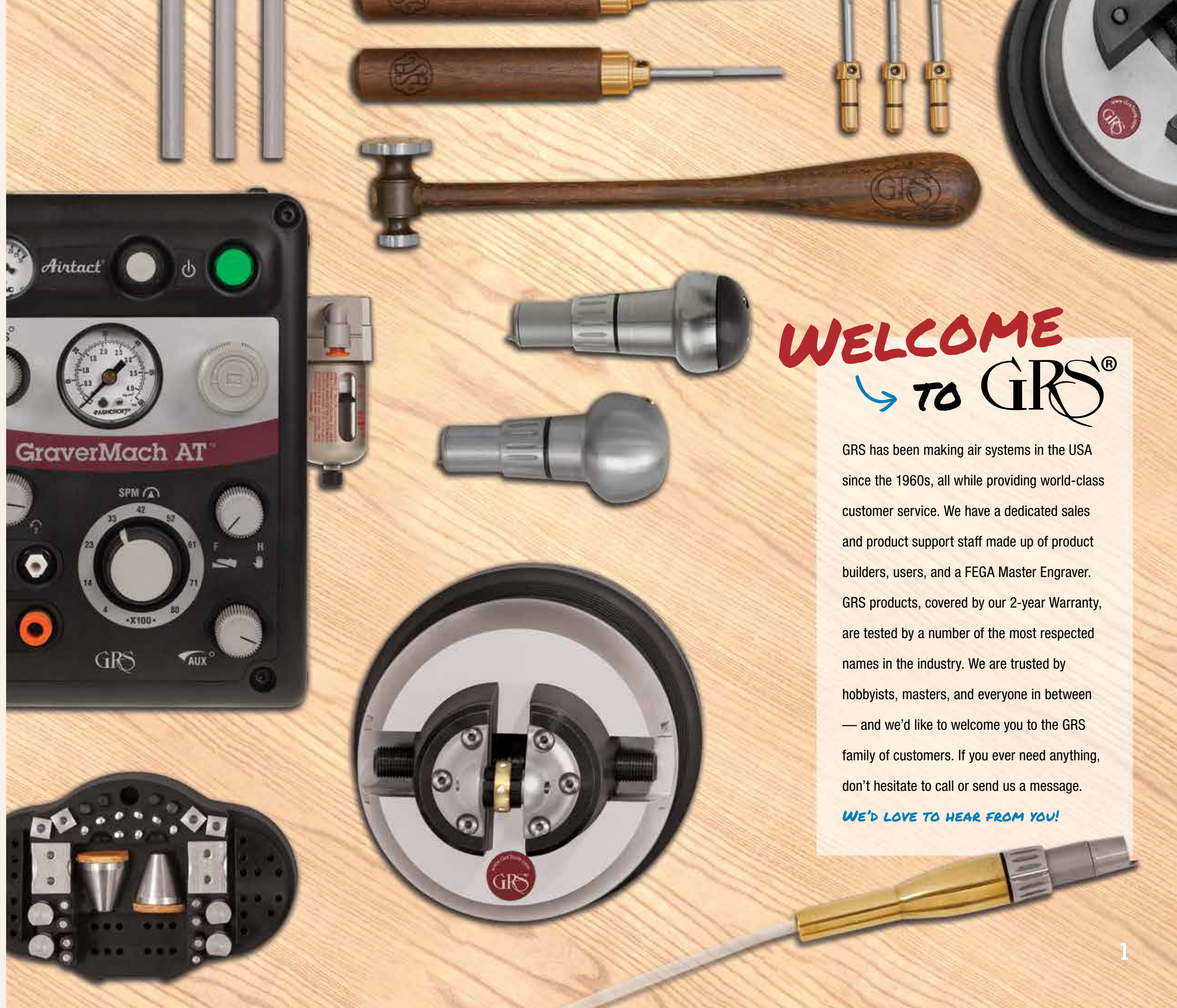

GRS[®] PRODUCT CATALOG 2020

CONTENTS

- 02 Customer Work
- 04 General Tool Setup
- 06 Air Systems & Handpieces
- 18 Air Compressors
- 20 Workholding
- 34 BenchMate & Jewelry Tools
- 44 Tool Sharpening
- 50 Gravers & Accessories
- 64 Microscopes & Optical Tools
- 70 Surface Prep & Finishing
- 72 Practice & Project Pieces
- 74 Books & DVDs
- 76 General Information



WELCOME ↳ TO GRS®

GRS has been making air systems in the USA since the 1960s, all while providing world-class customer service. We have a dedicated sales and product support staff made up of product builders, users, and a FEGA Master Engraver. GRS products, covered by our 2-year Warranty, are tested by a number of the most respected names in the industry. We are trusted by hobbyists, masters, and everyone in between — and we'd like to welcome you to the GRS family of customers. If you ever need anything, don't hesitate to call or send us a message.

WE'D LOVE TO HEAR FROM YOU!



johnnyoro - JOHN SORICH IV



msidengraver - MIKE SIDERIO



hm.jewelry - HAYDEN MAYER



biggsandrew - ANDREW BIGGS

WE LOVE SEEING YOUR WORK! EVERYTHING FROM RINGS AND THINGS...

GRS customers are the best in the world, and we like to take care of you with more than just making tools that solve problems. That's why we love to promote your artistry and continually feature the work our customers share.

...TO KNIVES, FIREARMS, AND EVEN OUR OWN TOOLS!

The possibilities are endless with tools from GRS, and the artisans who share their work prove this time and time again. We're blown away with what we see — and here are just a few examples of work from our customers. Kudos to all!

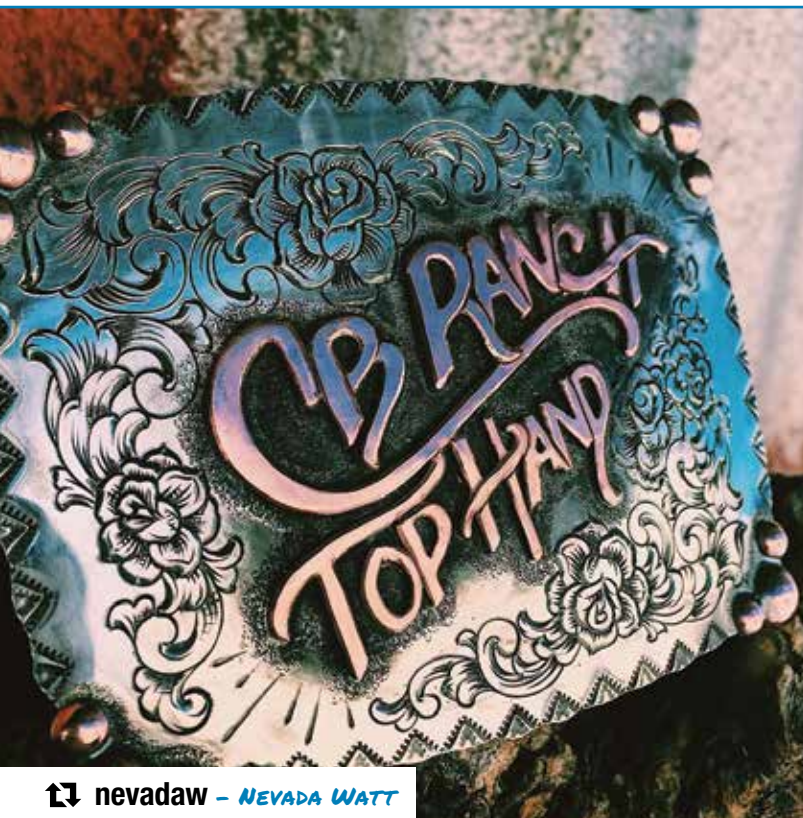

nevadaw - NEVADA WATT



roman.karakurkchi - ROMAN KARAKURKCHI



markdupp - MARK DUPP



adamguzzon - ADAM GUZZON

UNDERSTANDING HOW AIR TOOLS WORK

GRS Air Systems are an essential part of daily work for many engravers, stone setters, and other artisans all over the world. Oil-free compressed air travels through the Air System, where it is harnessed and regulated to create the finest control. By setting the speed on the unit, the user is able to work at a consistent speed while applying the power they require via the foot control or hand control. Air pulses then travel into the handpiece where a spring, piston, and anvil deliver smooth strikes, transferring impact to the graver.



GraverMax® G8
PAGE 6



GraverMach® AT
PAGE 6



GraverSmith®
PAGE 9

ADD AN AIRTACT TO THE G8 OR SMITH SYSTEM FOR HAND CONTROL!



Standard Handpiece + Tool with QC Tool Holder



Standard or AT Handpiece + Tool with QC Tool Holder



Standard Handpiece + Tool with QC Tool Holder

JUST GETTING STARTED? THESE ITEMS ARE WHAT WE RECOMMEND...

1. Oil-Free Air Compressor
2. GRS Air System
3. GRS Handpiece
4. Graver or Tool
5. Sharpening Equipment
6. Workholding
7. Magnification
8. Sturdy Work Surface
9. Adequate Lighting
10. Training Classes, Books, DVDs

AIR SYSTEMS



GraverMach® AT

\$1946

#004-965

- Instant switching to hand or foot control
- Separation of speed and power
- Predictable ultra-smooth start up
- Auxiliary port for Ultra 850, air gun, or other

Length	13"
Width	6"
Height	8.2"
Weight	22.7 lb

HAND OR FOOT CONTROL

GraverMax® G8

\$1385

#004-995

- Separation of speed and power
- Predictable ultra-smooth start up
- Auxiliary port for Ultra 850, air gun, or other
- Add Airtact Control System for hand control

Length	12"
Width	5.2"
Height	8.2"
Weight	20.2 lb

THE GRAVERMACH AT AND THE GRAVERMAX G8 AIR SYSTEMS BOTH OFFER...

- Two Handpiece Connections
- Airtact Auxiliary Air Connection
- Accurate Air Control
- Variable Strokes Per Minute (400-8000)
- Foot Control Included
- 2-Year Warranty



American-Made
QUALITY

These innovative systems harness the power of air so you can work faster, more efficiently, and with less fatigue. Use any of our air systems for your engraving and stone setting needs.



AIR SYSTEM UPGRADE

GraverSmith®

\$913

#004-895

- Updated motor for longevity
- Same power output as the GraverMax G8 and GraverMach AT
- Ideal for hobbyists up to master-level artisans
- Designed to be ultra-durable for many work environments
- Separation of speed and power
- 2-Year Warranty
- Foot control included

Length	10"
Width	5.8"
Height	9"
Weight	15.45 lb

Airtact Control System

\$454

#004-935

- Upgrade non-AT air systems to add hand control and more
- Two handpiece connections
- Airtact Handpiece required
- Compatible with all GRS systems excluding the GraverMeister

Length	6.5"
Width	3.7"
Height	4.8"
Weight	5.75 lb

"I CAN DO THE SAME QUALITY OF WORK WITH A GRAVERSMITH AS I CAN WITH A GRAVERMACH AT OR A GRAVERMAX G8."

Sam Alfano, Master Engraver

MADE IN EMPORIA, KANSAS

Visit youtube.com/grstools to learn more about GRS tools made in the USA.

AIRTACT HANDPIECES



Monarch AT Handpiece

\$400

#004-921-ATSS

- Designed for the finest shading and cutting techniques
- More traditional knob shape offers a comfortable feel
- Ideal for fine shading, bulino, and delicate work



Magnum AT Handpiece

\$444

#004-940-ATSS

- Full range of power from finest shading to heavy hammering
- Great for large hand sizes
- Ergonomic knob shape provides comfort

MORE PRODUCTS AVAILABLE ONLINE
visit grs.com

AIRTACT HANDPIECE REQUIREMENTS + FEATURES

GraverMach® AT or Air System with Airtact Control System

Oil-Free Compressed Air

Hand and Foot Control

Not for use with GraverMeister

Traditional Shape

901 AT Handpiece

\$400

#004-901-ATSS

- Fits most engraving and stone setting needs
- Great for microengraving, deep relief, bead raising, hammer setting, and more
- Ergonomic knob shape offers comfort for extended use
- Comfortable for most hand sizes



OUR MOST POPULAR AIRTACT HANDPIECE

EasyAT Palm Cap

- Creates a larger area of activation using hand control
- Increased sensitivity for better performance
- Available in three sensitivities

EasyAT Palm Cap, 3 Pack

\$29.95 Includes one Light, Medium, and Heavy Palm Cap.
#004-936



EasyAT Palm Cap, Light

\$13.25
#004-937



EasyAT Palm Cap, Medium

\$13.25
#004-938



EasyAT Palm Cap, Heavy

\$13.25
#004-939

STANDARD HANDPIECES

Monarch Handpiece

\$315

#004-921

- Designed for the finest shading and cutting techniques
- More traditional knob shape offers a comfortable feel
- Ideal for fine shading, bulino, and delicate work

BEST FOR FINE TECHNIQUES



Monarch Handpiece Kit

\$365

#004-926

Includes Monarch QC handpiece, QC Hand Handle (#004-805), 6 QC Tool Holders, and QC tool tray.

Magnum Oval Handpiece

\$392

#004-940-OVAL

- Added weight and length provides more power than the standard palm knob
- Full range of power from finest shading to heavy hammering
- Great for large hand sizes
- Ergonomic knob shape provides comfort

AIR HOSE PROMOTES A HANDLEBAR GRIP



STANDARD HANDPIECE REQUIREMENTS



Oil-Free Compressed Air



GRS® Air System



Foot Control



Not for use with GraverMeister

Stainless Steel



OUR MOST POPULAR HANDPIECE

901 Handpiece

\$315

#004-901

- Fits most engraving and stone setting needs
- Great for microengraving, deep relief, bead raising, hammer setting, and more
- Ergonomic knob shape offers comfort for extended use
- Comfortable for most hand sizes

901 Handpiece Kit

\$365

#004-910

Includes 901 Handpiece, QC Hand Handle (#004-805), 6 QC Tool Holders, and QC tool tray.

FULL POWER RANGE



Magnum Handpiece

\$360

#004-940

- Full range of power from finest shading to heavy hammering
- Great for large hand sizes
- Ergonomic knob shape provides comfort

Maestro Original Handpiece

\$325

#004-947

- Longer length and shape provides a handlebar grip
- Combines durable brass and heat-treated steel for added weight
- Ideal for fine techniques, scrimshaw, light texturing, and light stippling

DESIGNED FOR
SCRIMSHAW + STIPPLING

Maestro EX Handpiece

\$345

#004-905

- 3.5 times heavier piston delivers more power (compared to the original Maestro)
- 20% larger diameter increases weight for more power
- Ideal for stippling, texturing, punch dot, light sculpting, hammering, and more

POWERFUL +
VERSATILE

Maestro MX Handpiece

\$373

#004-909

- 72% heavier piston (compared to the Maestro EX) delivers the most power
- Size gives the widest range of power and control
- Ideal for hammering, texturing, light to heavy sculpting, stippling, stone setting, and more

WIDEST POWER
RANGE

ASK ABOUT ADDING
AN AIR TACT THUMB /
FINGER ELEMENT!

Maestro Handpieces

GRS® Air System

Foot Control

Not for use with GraverMeister



Handpiece Storage Strip

\$15.95

#024-210

- Durable, high-quality molded plastic for long-term use
- Holds up to 4 handpieces of varying size
- Allows for easy access and quicker handpiece changes

CLASSIC HANDPIECES

GRS® Air System

Oil-Free Compressed Air

Not for use with GraverMeister

Foot Control



610 Handpiece

\$345

#004-610

- Holds square tools up to 0.10" (2.5 mm) and round tools up to 0.13" (3.3 mm)
- Stainless steel construction provides long-term durability
- Not QC Compatible



QC 710 Handpiece

\$341

#004-710

- Medium to heavy power range
- Used for stone setting, hammering, and medium to deep engraving



QC 720 Handpiece

\$431

#004-720

- Very powerful impact handpiece
- Great for wood carving, very heavy metal engraving, or hammering
- Popular with motorcycle and car part engravers

ROTARY
HANDPIECE



GRS® Ultra 850 Handpiece

\$508

#004-850

- 320,000 RPM motor provides effortless use in many materials
- Great for background removal, texturing, glass etching, and more
- Accepts 1/16" (1.6 mm) diameter bur shanks
- Not compatible with the GraverSmith or GraverMeister

THE CLASSIC INNOVATIVE AIR SYSTEM FROM GRS

GraverMeister®

\$1914

#001-842

- Built-in vacuum pump saves space
- Easily controls air flow with foot control
- Classic design features patented technology
- Portable
- 1600-2400 SPM
- 110V Only



915 Handpiece

\$341

#004-915

- Provides excellent control for GraverMeister use
- Traditional knob shape promotes ergonomic grip
- Ideal for general engraving and stone setting

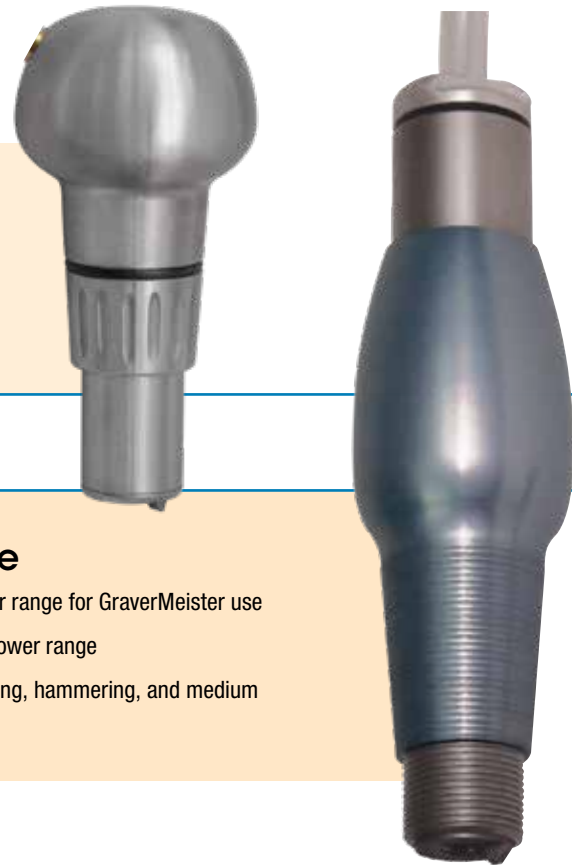

GraverMeister Handpieces



QC 712 Handpiece

\$345

#004-712

- Offers a wide power range for GraverMeister use
- Medium to heavy power range
- Used for stone setting, hammering, and medium to deep engraving

MORE PRODUCTS AVAILABLE ONLINE visit grs.com

NSK Emax EVolution

\$1128

#002-910-EVO

- Maintains constant speeds, even under load
- Smooth and quiet operation for precision work
- Bidirectional vibration-free rotation
- Quick release lever handpiece
- Great for bur work, drilling, hand sharpening, and more

Includes Control Unit, Lever Type Handpiece, (1) Collet Chuck 1/8", (1) Collet Chuck 3/32", Handpiece Holder & Stand, Wrench (7 x 5.1), and Pin Wrench.



NSK Emax EVolution Torque Multiplier/Speed Reducer, 4:1

\$295

#002-934

- Decreases speed, increasing torque for more power
- Increased torque creates cleaner drilling and bur work
- For use with the NSK Emax EVolution



Collets

NSK Emax EVolution 1/16" Collet

\$79.95

#002-924

NSK Emax EVolution 3/32" Collet

\$67.00

#002-925

NSK Emax EVolution 1/8" Collet

\$69.95

#002-926

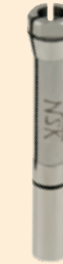

Diamond Wheels

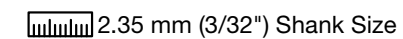

Shape or Polish Gravers



Gray Roughing Diamond Wheel

\$36.70

#023-122

- Provides quick shaping for carbide and HSS gravers
- Easily mounts in a micromotor (like NSK EVO or Electer) or flex-shaft (Foredom®) hanging motor
- Fast roughness for use at 20,000 RPM max

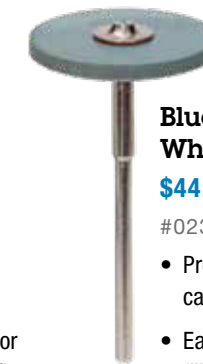

Blue Medium Diamond Wheel

\$44.65

#023-123

- Provides refined shaping for carbide and HSS gravers
- Easily mounts in a micromotor (like NSK EVO or Electer) or flex-shaft (Foredom®) hanging motor
- Medium roughness for use at 5,000 RPM max

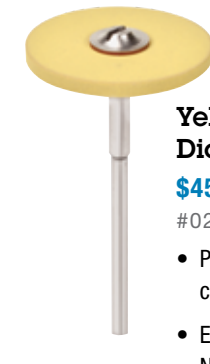

Yellow Rubber-Bond Diamond Polishing Wheel

\$45.10

#023-120

- Provides perfect mirror finish for carbide and HSS gravers
- Easily mounts in a micromotor (like NSK EVO or Electer) or flex-shaft (Foredom®) hanging motor
- Mirror finish wheel for use at 5,000 RPM max

AIR COMPRESSORS

California Air 4610AC Ultra Quiet Air Compressor, 110 V

\$377

#004-984

- Increased duty cycle and longer continuous run times
- Only generates 60 decibels of sound for quiet operation
- Rust-resistant aluminium tank
- Oil-free 1.0 HP Motor



Val-Air Air Compressor

\$1416

#004-678

- Virtually noiseless for a quiet work environment
- Features automatic operation for less hassle
- Upgraded heavy-duty 1/2 horsepower pump for better performance
- Includes in-line moisture trap and coalescing filter
- Internally painted tank to prevent rust
- Fan included



MORE PRODUCTS
AVAILABLE ONLINE
visit grs.com

The GRS Advantage

Compressors purchased directly from GRS include the necessary hook-up kit to connect it to our Air Systems.

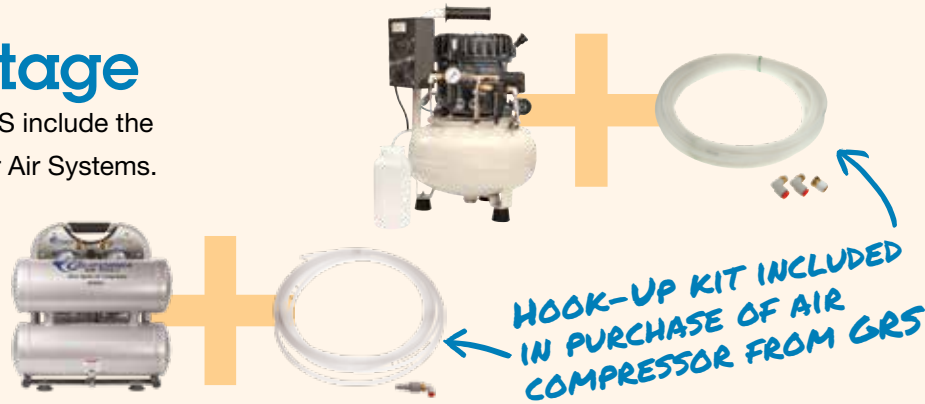

Please Note: To connect a compressor not purchased from GRS, a Hook-Up Kit is required.

Hook-Up Kit for California Air 4610AC Compressor

\$44.55

#004-983

- Use as a replacement hose kit
- 50' (15.24 m) of 1/4" (6.35 mm) hose and brass fitting
- Included with compressors purchased from GRS

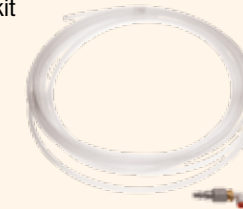

Hook-Up Kit For Compressors

\$58.05

#004-527

- Use as a replacement hose kit
- 50' (15.24 m) of 1/4" (6.35 mm) hose and brass fittings
- Included with compressors purchased from GRS

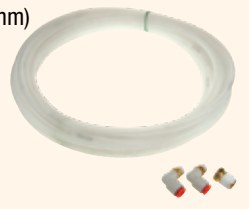

Coalescing Air Filter / Oil-Removal Kit

\$112

#004-730

- Updated spacer-bracket for better mounting
- Allows use of an oil-type compressor
- Designed for 1/4" hose



Quick Disconnect Kit

\$31.75

#004-615

- Allows quick switching of air handpieces
- Includes one main body and two connectors



Silentaire Compressor Oil

\$25.35

#022-163

- Formulated for use with SilentAire compressors
- 24 fl oz



WORKHOLDING

MicroBlock®

\$305
#003-683

- Small compact design is perfect for stone setting, jewelry work, and small engraving
- Easily tilted to check stone depth, or adapt to work needs
- Self-centering jaw system makes precision work easier
- Rotational resistance from free to locked
- Ideal for microscope work
- 80 mm Diameter, 50 mm Open

Includes MicroBlock Vise, 4 pins, 2 wrenches, 6 screws, plastic base, 1 plastic hex key, and Thermo-Loc Sample Kit.

FOUR POUNDS



MicroBlock® + Attachment Set

\$395
#003-684



StepRisers for MicroBlock®

\$23.05
#003-674

- Reduces physical fatigue from improper vise heights
- Increases efficiency with fast height adjustability
- Securely adds 0.5" with each riser

Set of 5. Each adds 0.5" (12.7 mm) to working height.



MicroBlock® XL

\$405
#003-773

- Larger than the original MicroBlock® but still provides needed mobility
- Ideal for stone setting, jewelry work, and small to medium engraving
- Self-centering jaw system makes precision work easier
- Rotational resistance from free to locked
- Ideal for microscope work
- Compatible with all MicroBlock accessories
- 100 mm Diameter, 70 mm Open

Includes MicroBlock XL Vise, 4 pins, 1 plastic base, 1 rubber base, 1 plastic hex key, 1 wrench, 6 screws, and Thermo-Loc sample kit

MicroBlock® XL + 520 Attachment Set

\$495
#003-774



3.375" TALL



3.8" TALL



MicroBlock® ACCESSORIES

MicroBlock® Rubber Base

\$10.50
#003-439

- Provides additional friction and control
- Compatible with all GRS MicroBlocks

MicroBlock® Short Jaw Kit

\$96.15
#003-651

- Reduces the GRS MicroBlock or MicroBlock XL jaws by 0.374" (9.5 mm)
- Compatible with the Alexandre Ring Fixture and I.D. Ring Holder
- Features identical pin holes and threads compared to the original MicroBlock jaws
- Ideal for microscope work

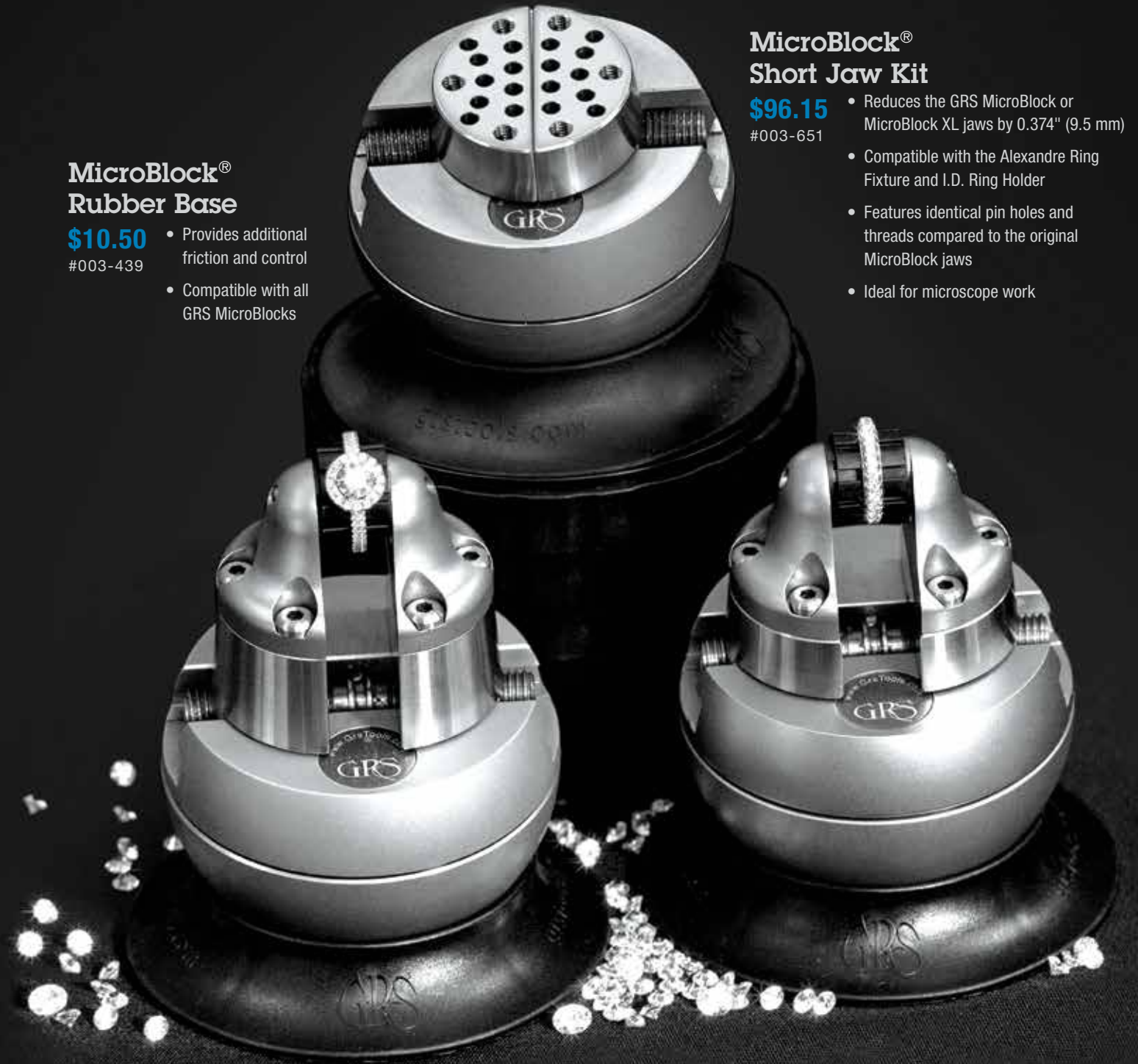

For information about the Alexandre Ring Fixtures (shown above), see page 40.

Standard Block

\$525

#003-530

- Ideal for traditional jewelry work, stone setting, and general engraving
- Rotational resistance from free to locked
- Machined from solid stainless steel for durability and longevity
- 130 mm Diameter, 76 mm Open

Includes upper jaw plates, 4 pins, base, 1 plastic hex key, and wrench.



← 19 POUNDS

Standard Block + Attachment Set

\$617

#003-531



↑ 6" TALL



20.25 POUNDS



Low Profile Vise

\$695

#003-615

- Ideal for all engraving applications
- Rotational resistance from free to locked
- Machined from solid stainless steel for durability and longevity
- Designed to be used with a turntable and microscope
- 147 mm Diameter, 89 mm Open

Includes vise, upper jaw plates, 5 pins, base, 1 plastic hex key, and wrench.

↑ 5.75" TALL



MagnaBlock

\$748

#003-021

- Ideal for holding large work, hammer and chisel engraving, and more
- Rotational resistance from free to locked
- Machined from solid stainless steel for durability and longevity
- For use with or without a microscope
- 147 mm Diameter, 89 mm Open

Includes upper jaw plates, 5 pins, base, 1 plastic hex key, and wrench.

↑ 30 POUNDS



MagnaBlock + Attachment Set

\$830

#003-522



↑ 7.25" TALL



USE IT WITHOUT A TURNABLE



Positioning Vise

\$998

#003-541

- Positionable center of rotation allows maximum flexibility and accuracy while working, especially under a microscope
- Machined from solid steel for durability and longevity
- As the largest vise made by GRS, this vise provides the most stability and adjustability available
- 180 mm Diameter, 89 mm Open

Includes upper jaw plates, 5 pins, base, 1 plastic hex key, and wrench.

↑ 42 POUNDS

↑ 7.75" TALL



WORKHOLDING

Leather Pads

\$8.10

#003-609

- Thick, top-grain leather provides an excellent non-marring surface
- Perfect for safely holding parts in any engraving block or vise
- Use with diamond spray for polishing tools



Magnetic Leather Vise Jaw Pads

\$11.20

#023-133

- Thick, top-grain leather provides an excellent non-marring surface
- Perfect for safely holding parts in any engraving block or vise
- Magnets hold pads securely in place



Super Pins

- Heavy-duty plastic over steel pins are durable
- Ideal for holding larger items without marring

1/4" Super Pins

\$12.95

#003-546



3/8" Super Pins

\$8.35

#003-547



Universal Positioning Pin Vise

\$230

#003-775

- Self-centering jaw system
- Ideal for smaller items such as watch parts, pendants, small knives, and more
- Always work within center under the microscope
- Bidirectional rotation
- Fits all GRS vises

Includes 1 rubber base

VISIT [YOUTUBE.COM/GRSTOOLS](https://www.youtube.com/grstools) TO SEE THE UNIVERSAL POSITIONING PIN VISE IN ACTION!



Ball Vise 1/4" Hex Key

\$19.00

#003-662

- Knurled aluminum handle provides easy gripping surface
- Low-profile design means it can stay in chuck while vise is in use
- Fits all GRS vises except the MicroBlock® & MicroBlock® XL



520 Attachment Set

\$118

#003-520

- Includes a variety of pins for upper jaw plates on GRS blocks
- Solves workholding problems quickly

Includes 4 one-half Thermo-Loc sticks, 8 small pins, 4 flat square pins, 2 rectangular inset-curve pins, 4 thick round inset pins, 8 rubber-coated pins, and 2 leather-faced ring clamp pins in molded base.



FITS ALL GRS VISES EXCEPT MICROBLOCK AND MICROBLOCK XL

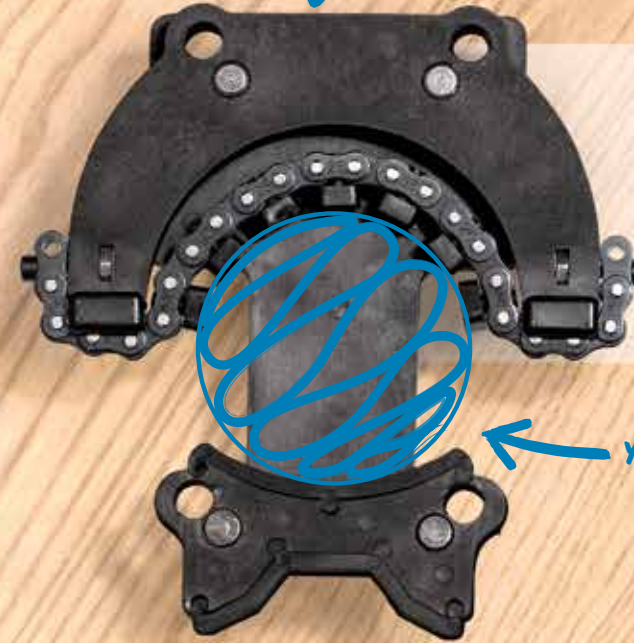

Contour Vise Jaws

\$75.90

#003-623

- Safely holds irregularly shaped parts to eliminate or reduce potential surface damage
- Fits the top holes of most GRS vises and blocks
- Hard, rubber-lined jaws conform to grip using minimal clamping force

YOUR WORK HERE

Knifemakers Contour Vise

\$107

#003-622

- Secures knives in seconds without high clamping force
- Holds unusual and compound shapes easily
- Adjustable for a wide range of widths and depths

WORKS WITH ALL GRS VISES EXCEPT MICROBLOCK + MULTI-PURPOSE VISE



WORK BY PROFESSIONAL HAND ENGRAVER AND GRSTC INSTRUCTOR JEFF PARKE

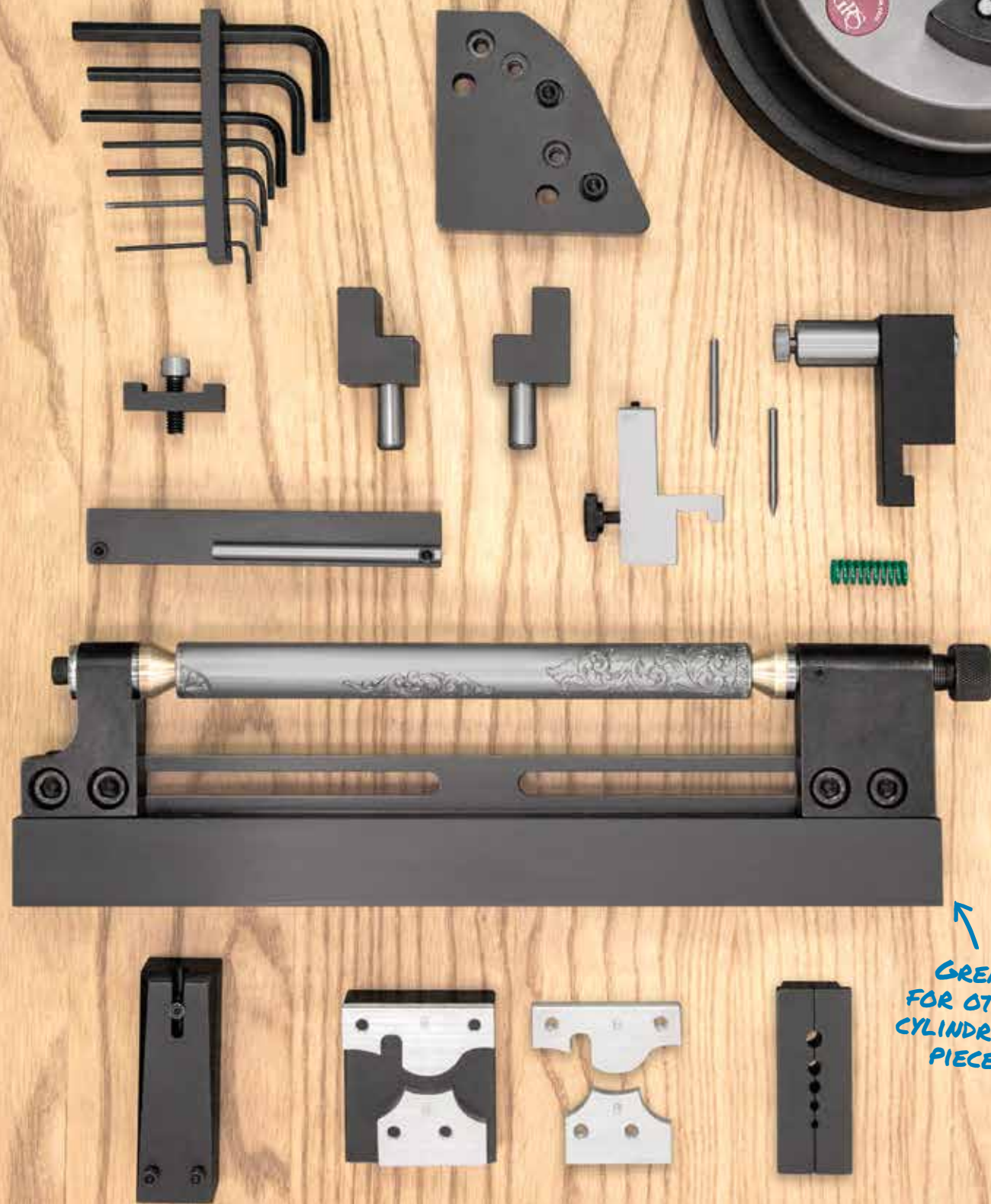

Mike Dubber Fixture Set

- Designed by FEGA Master Engraver Mike Dubber
- Provides great workholding solutions for parts of the Single Action Army Revolver

Complete Set

\$795
#003-726

Includes Barrel and Cylinder Holder, Horizontal Scribe Holder, Vertical Scribe Holder, Backstrap Holding Plates, Ejector Tube Holder, Hammer Holder with Extra Aluminum Jaw Set, Trigger Guard Holder, Screw Holder, Loading Gate Stabilizer, Frame Bracket Holders, Heavy Spring, Hex Wrench Set, Carbide and Stainless Steel Scribes, and Storage Tray.

SAA Fixture Set without Barrel Fixture

\$459
#003-725

SAA Barrel Fixture

\$385
#003-715

GREAT FOR OTHER CYLINDRICAL PIECES



Workholding Plate Assembly

\$47.40

#003-698

- Designed to hold work without damage
- Use with modeling clay or Thermo-Loc
- Perfect for detailing thin, light pieces
- Clamps securely in vise jaws

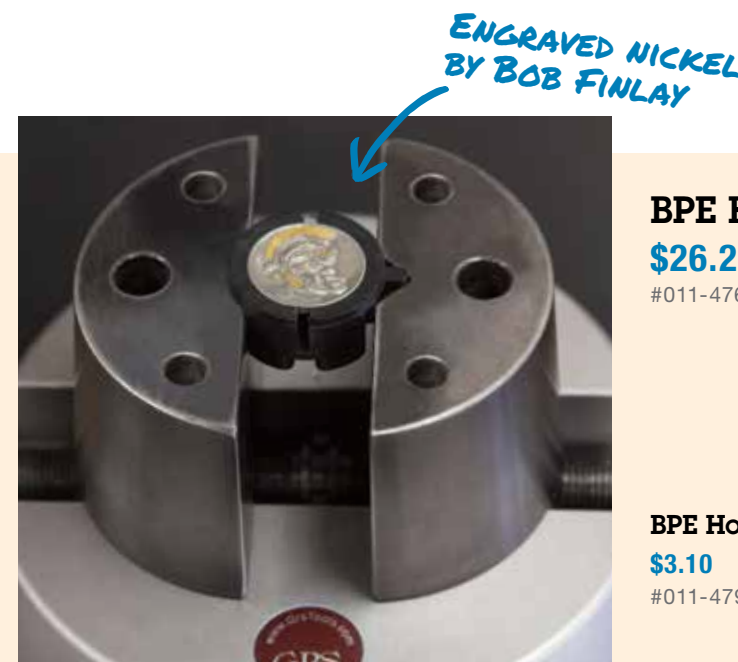

BPE Hobo Nickel Kit

\$26.20

#011-476

- Securely hold nickles in the vise jaws
- Easily mask common areas to keep them intact
- Protect finished nickles with storage cases



BPE Hobo Nickel Case

\$3.10

#011-479

- Clear for easy viewing
- Durable plastic for safe storage
- Fits nickles perfectly



SINGLE CASE. NICKEL NOT INCLUDED.



Rifle Scope Ring Fixture

\$74.95

#004-699

- Securely holds rifle scope rings from the inside
- Fits 1" and 30 mm inner-diameter scope rings
- Similar to the Horizontal Ring Holder (#004-679)

MORE PRODUCTS AVAILABLE ONLINE
visit grs.com

WORKHOLDING

Thermo-Loc®

- Rigid at room temperature yet becomes pliable when heated or warmed
- Developed to hold irregularly shaped or fragile items
- Simply reheat and reuse
- Non-toxic and biodegradable



Thermo-Loc® Starter Kit

\$49.95

#003-667

Includes 6" (152.4 mm) square special non-stick PTFE material pad for microwave use and 1 pound of Thermo-Loc. 1 lb = approx. 60 sticks.

Thermo-Loc® Sticks, 0.5 lb (225 g)

\$25.60

#003-664

0.5 lb = approx. 30 sticks

Thermo-Loc® Sticks, 1.0 lb (450 g)

\$43.75

#003-665

1 lb = approx. 60 sticks

Thermo-Loc® Sticks, 5.0 lb (2.26 kg)

\$166

#003-666

5 lb = approx. 300 sticks

Thermo-Loc Jaw Set

\$93.45

#003-745

- Specially machined to keep Thermo-Loc in place
- High-quality stainless steel
- Great for making custom forms for working on several identical pieces
- Works with Universal Pin Vise (#003-775) and BenchMate Pin Vise (#004-879)



ENGRAVED KEY TAG
BY SERGET MANAENKO

Thermo-Loc
JAW SET IN USE

Thermo-Loc® Handles

\$15.15

#004-800

- Thermo-Loc core securely holds tools
- Simply reheat and change tools
- Great for files, traditional gravers, and more



Low-Friction PTFE Pad for Thermo-Loc®

\$17.25

#003-291

- Microwavable pad for heating Thermo-Loc
- Allows Thermo-Loc to be heated without sticking

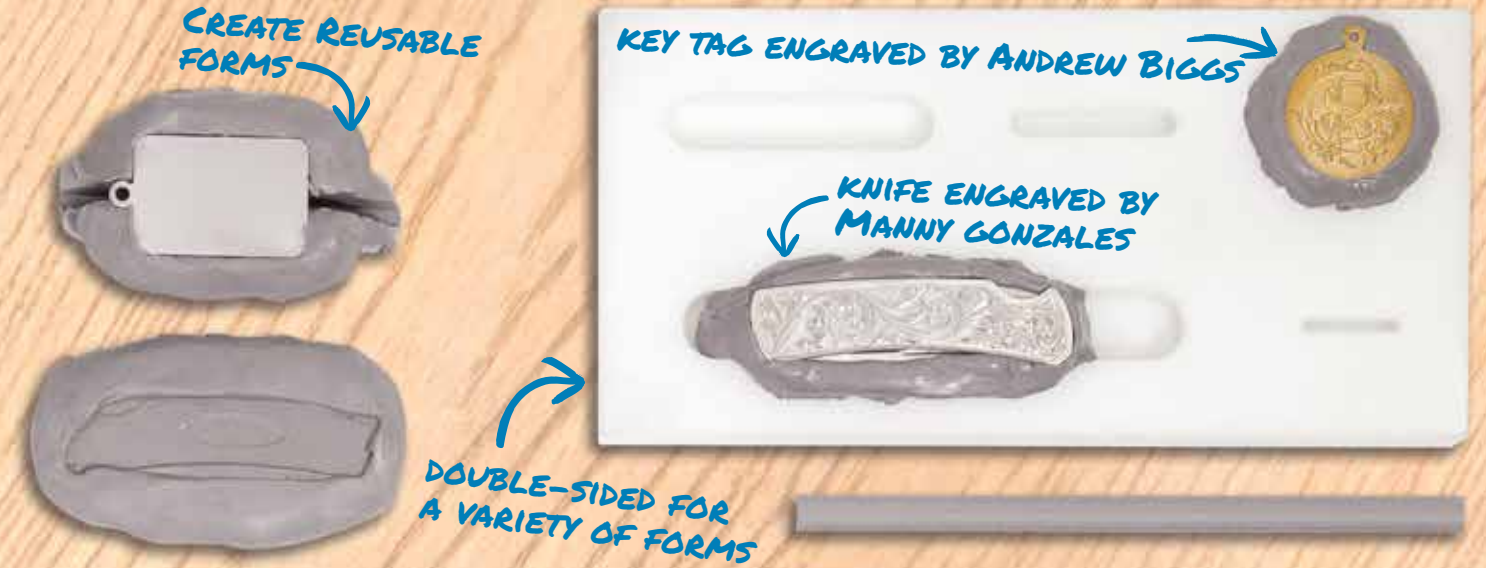

CREATE REUSABLE FORMS

KEY TAG ENGRAVED BY ANDREW BIGGS

KNIFE ENGRAVED BY MANNY GONZALES

DOUBLE-SIDED FOR A VARIETY OF FORMS

Thermo-Loc Form Block

\$37.15

#003-699

- Easily allows users to make custom Thermo-Loc workholding fixtures
- Provides a variety of slot sizes for different work sizes
- Create reusable forms for repeat projects



FORM BLOCK CREATES FLANGE THAT FITS IN VISE JAWS



BRACELET ENGRAVED BY DIANE SCALESE



WORKHOLDING

FOR USE WITH THE POSITIONING VISE (#003-541)

Satellite Fixed Top Package

\$549

#003-750

- 10-inch steel surface
- Provides a large area for adjustability
- Adds stability to the Positioning Vise



Satellite Turntable Stand

\$443

#003-735

- Allows users to easily work on larger pieces
- Provides incredible stability
- Take control of your work and find freedom from your bench
- Adjusts from 18" to 29" to create ideal work elevations
- Requires turntable, such as the Satellite Turntable (#003-656)



Satellite Catch Pan

\$83.50

#003-738

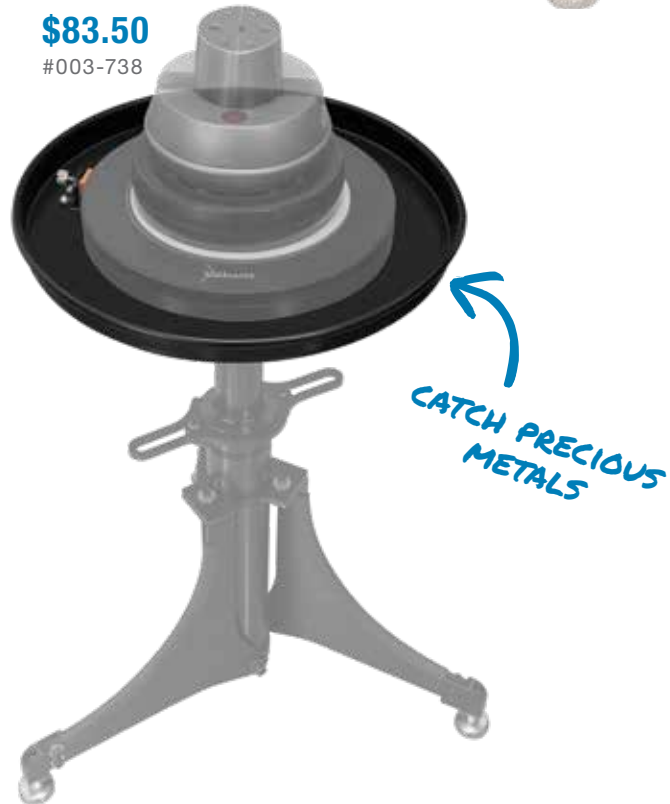

CATCH PRECIOUS METALS

Satellite Turntable

\$438

#003-656

- Provides a completely overhauled bearing system for minimum maintenance
- Has an incredibly smooth, quiet glide
- Sealed profile limits contamination from metal chips and debris

Includes Brake Kit (#003-343) and Low-Friction PTFE Pad (#044-165). Does not include vise, Satellite Stand, or Centering Post.



Satellite TURNTABLE



18"-29" HEIGHT ADJUSTMENT

FREEDOM FROM YOUR BENCH

Satellite Turntable Package

\$831

#003-740

- Allows users to easily work on larger pieces
- Provides incredible stability and easy storage when not in use
- Adjusts from 18" to 29", creating ideal work elevations
- Includes smooth and quiet Satellite Turntable (#003-656)

WORKHOLDING



0.66" HIGH
(16.78 MM)
10" ROUND
(254 MM)

GRS® Turntable Base Kit

\$341

#003-616-V2

- Lets you reposition the work's center of rotation for working under a microscope
- Features a 10" (254 mm) diameter turntable surface
- Designed with a unique bearing system coupled between the two flat ground steel plates
- Includes a removable centering post to position the turntable directly under the microscope

Includes Brake Kit (#003-343) and Low-Friction PTFE Pad (#044-165), also sold separately. Does not include vise or block.

MORE PRODUCTS
AVAILABLE ONLINE
visit grs.com

1.1" HIGH
(27.82 MM)
10.1" ROUND
(256.54 MM)

Satellite Turntable

\$438

#003-656

- Provides a completely overhauled bearing system for minimum maintenance
- Has an incredibly smooth, quiet glide
- Sealed profile limits contamination from metal chips and debris

Includes Brake Kit (#003-343) and Low-Friction PTFE Pad (#044-165). Does not include vise, Satellite Stand, or Centering Post.

SATELLITE STAND
NOT INCLUDED



Turntable Mount Kit

\$21.55

#004-672

Required to attach Satellite Turntable (#003-656) to large block shelf.



WORKHOLDING

1. MOUNT TO A BENCH



Optional Mounting Adapter

\$32.95

#004-559

- Add a sturdy, stable mounting surface to curved or thin bench tops for attaching the Fixed Mounting Plate



Fixed Mounting Plate

\$21.25

#004-557

- Attach directly to the front of a thick bench, an Optional Mounting Adapter, or an Adjustable Height Bracket for an easy workholding solution

2. ADJUST HEIGHT



Adjustable Height Bracket and Fixed Mounting Plate Kit

\$59.95

#004-666

- Adds 4" to work support
- Adjustable in 1/2" increments.

3. ATTACH SHELF



Standard Block Shelf

\$49.95

#004-578

- Recommended for use with the Standard Block, MicroBlock, and MicroBlock XL



Large Block Shelf and Adjustable Height Bracket Kit

\$91.50

#004-665

- Uses fixed mounting plate to hold a vise below the front of a bench
- Allows the vise to be the same height as a bench pin
- Provides a secure, sturdy surface for workholding
- Secure surface for mounting a turntable

Block Vise Shelf Support

\$70.05

#003-649

- Adds stability to reduce vibration when using a Block Shelf

BENCHMATE® & JEWELRY TOOLS

BenchMate Encore® QC Fixtures

- Ideal for stone setting, small engravings, and precision work
- Great for use with or without microscope
- High-quality material is durable and well made

WORK BY MITCHELL LURTH



Vertical I.D. Ring Holder
\$72.40

#004-878

- Vertical form for easy access to the sides of rings

Includes Vertical I.D. Ring Holder and 10 Mandrels.

WORK BY TODD DANIELS



Horizontal I.D. Ring Holder
\$83.20

#004-877

- Holds ring securely from the inside

Includes Vertical I.D. Ring Holder and 10 Mandrels.

WORK BY ANDREW BIGGS



Pin Vise
\$225

#004-879

- Features a self-centering jaw system

WORK BY MITCHELL LURTH



Wood Block
\$45.50

#004-716

- Ideal for gluing work in place

ENGRAVED PRACTICE PLATE BY SERGEY MANAENKO WITH STONE SETTING BY NADJA IHSEN



PitchCup
\$45.00

#004-714

- Filled with pitch that softens when heated
- Hold fragile, small, or irregular pieces



BenchMate QC Storage Strip
\$14.95

#024-213

- Storage solution for all BenchMate QC Fixtures

PitchCup without Pitch
\$37.50

#004-713

- Great for Thermo-Loc, pitch, or other workholding material

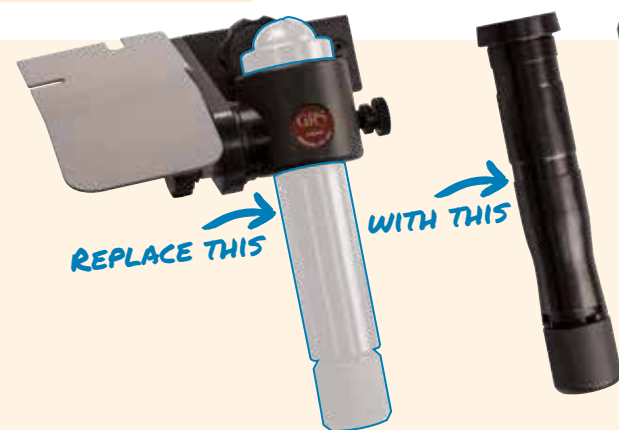

REPLACE THIS

WITH THIS



BenchMate Retrofit Kit
\$139

#004-845

- Upgrade your GRS Original BenchMate for QC fixture compatibility

AND USE QC FIXTURES IN YOUR ORIGINAL BENCHMATE!



Extra Plastic Jaws for BenchMate
\$10.25

#004-558

- For use with the BenchMate. Package of ten plastic jaws.

BenchMate®

WORKHOLDING



CUTOUT FOR SUPERIOR ACCESS ANGLES AND BETTER CLEARANCE

TWO THREADED COLLAR RINGS FOR FAST AND EASY HEIGHT ADJUSTMENT TO THE MANDREL

QCX shown with the Vertical I.D. Ring Holder Fixture, sold separately (#004-878) or included in the Stone Setter's Package (#004-832).

BenchMate Encore® QC

- Holds work steady yet is easily repositionable to accommodate a range of techniques and jobs
- Arm measures 6" and features a cutout for superior access angles and better clearance when using tools
- Vertical position adjusts for maximum comfort and control
- Features drop and lock QC fixtures

Basic Package

\$349

#004-839

Basic Package includes BenchMate Encore QC, Fixed Mounting Plate (#004-557), Encore QC Accessory Pack with 4 Extra Plastic Jaws (#004-558), 2 wrenches (5/32" Allen and 3/16" hex), and 5 mounting screws.

Stone Setter's Package

\$498

#004-840

Stone Setter's Package includes BenchMate Encore QC, Fixed Mounting Plate (#004-557), Horizontal I.D. Ring Holder, Vertical I.D. Ring Holder, Bench Pin Kit (#004-556), Encore QC Accessory Pack with 4 Extra Plastic Jaws (#004-558), 2 wrenches (5/32" Allen and 3/16" hex), and 5 mounting screws.

BenchMate Encore® QCX

- Delivers the widest range of motion available from any hands-free workholding tool
- Easily keeps work centered under a microscope
- Holds work steady yet is easily repositionable to accommodate a range of techniques and jobs
- Features drop and lock QC fixtures

Basic Package

\$389

#004-831

Basic Package includes BenchMate Encore QCX, Fixed Mounting Plate (#004-557), Encore QCX Accessory Pack with 4 Extra Plastic Jaws (#004-558), 2 wrenches (5/32" Allen and large spanner), and 5 mounting screws.

Stone Setter's Package

\$546

#004-832

Stone Setter's Package includes BenchMate Encore QCX, Fixed Mounting Plate (#004-557), Horizontal I.D. Ring Holder, Vertical I.D. Ring Holder, Bench Pin Kit (#004-556), Encore QCX Accessory Pack with 4 Extra Plastic Jaws (#004-558), 2 wrenches (5/32" Allen and large spanner), and 5 mounting screws.



Bench Pin Kit

\$34.95

#004-556

Wood Replacement Pin

\$6.25

#004-108

EASILY SWITCH TOOLS WITH THE FIXED MOUNTING PLATE (#004-557)



Sawing Plates

Sawing Plate for Right Hand

\$39.55

#004-680

Sawing Plate for Left Hand

\$41.35

#004-684



ACCESSORIZE YOUR VISE

Multi-Purpose Vise

\$195

#004-628

- Precision-made steel vise adjusts for tilt and rotation on two axes
- Provides comfort and efficiency
- Uses the versatile "lift on / lift off" BenchMate mounting system



Attachment Set for Multi-Purpose Vise

\$140

#003-520MPV

- Includes a variety of pins for upper jaw plates on GRS blocks
- Solves workholding problems quickly

Includes 4 one-half Thermo-Loc sticks (not shown), 8 small pins, 4 medium dark pins, 4 flat square pins, 2 rectangular inset-curve pins, 4 thick round inset pins, 8 rubber-coated pins, 2 leather-faced ring clamp pins, and 2 pin plates in molded base. For use with the Multi-Purpose Vise (#004-628) for BenchMate.

THIRD-HANDS

GRS Third-Hands offer high quality, sturdy construction for aiding the soldering and holding process.



Third-Hand Attachments

Standard

\$51.95

#004-546

Short

\$47.50

#004-646

STANDARD = 3 POINTS OF ARTICULATION

SHORT = 2 POINTS OF ARTICULATION

Third-Hand with Base

Standard

\$68.35

#004-568

Short

\$55.15

#004-689

Includes Weighted Base

Third-Hand with Soldering Station

Standard Double

\$159

#004-570

Includes attached non-asbestos soldering station. Max 600°F (316°C).

Short Double

\$114

#004-545

Includes attached non-asbestos soldering station. Max 600°F (316°C).

High-Temp Soldering Platform

\$96.15

#004-691

- Perfect for brazing and soldering most precious and base metals
- Made for high-temperature work on platinum
- Works great with GRS Third-Hand Attachments with tungsten jaws
- Max operating temp: 3200°F (1760°C)

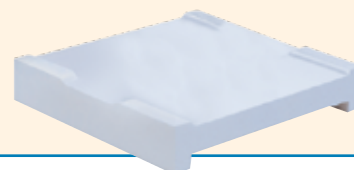

Soldering Board

6-Inch

\$13.85

#004-129

4-Inch

\$9.80

#004-130

- For indirect heating or soldering use with Third-Hand Attachments
- 6" surface aids in the soldering process
- Max 600°F (316°C)

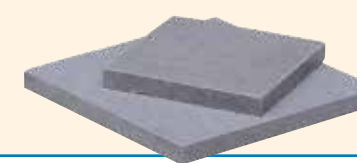

Soldering Station

\$39.95

#004-569

- Works with the BenchMate system
- Aids in the soldering process
- Max 600°F (316°C)

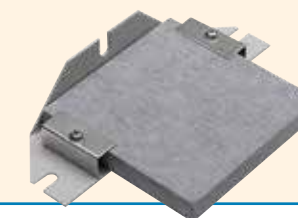

Steel Soldering Fingers

Narrow

\$11.50

#004-552

Wide

\$12.95

#004-553



- Works with the Third-Hand Attachments
- Aids in the soldering process
- Steel construction in narrow or wide format

Insulated Soldering Clamp

\$65.90

#004-592

- Works with the BenchMate system or in a vise

- Aids in the soldering process
- Max 600°F (316°C)



Third-Hand Jaw Point

Standard

\$8.70

#004-097

Tungsten

\$13.45

#004-097TUNG



GREAT FOR PLATINUM

RINGS BY TODD DANIELS



Inside Ring Holder

- Made for use in blocks and vises
- Holds rings securely from the inside
- Vertical form for easy access to the sides of a ring

Horizontal
#004-679
\$73.40

Vertical
#004-847
\$61.55



Extra Collet Set

- \$51.80 #004-616
- Replacement set of collets
 - Compatible with Horizontal Inside Ring Holder (#004-679) and Inside Ring Mandrel (#004-589)



Inside Ring Engraving Holder

- \$74.15 #004-697
- Unique holder secures rings, allowing easy access to the inside
 - Can be handheld or mounted in a vise
 - Made by GRS from solid steel to last a lifetime

ENGRAVE THE INSIDE OF A RING



Handheld Ring Clamp

- \$55.90 #004-625
- Lightweight for hand use
 - Parts are machined from solid aluminum and steel
 - Holds rings securely without marring
 - Does not fit BenchMate

← PRACTICE RING BY TODD DANIELS

Ring Clamps

- \$24.45 #003-550
- Leather-faced ring clamps for easy, secure workholding
 - Fits upper pin plates, MicroBlock®, and MicroBlock® XL



Inside Ring Mandrel

- \$95.05 #004-589
- Adds inside ring-holding capability to any BenchMate®
 - Allows greater access to the outside of ring
 - Prevents ring from flexing while working



I.D. Ring Holder

- \$83.20 #004-735
- Securely holds rings and cylindrical pieces for workholding
 - Equal expansion pressure eliminates uneven grip
 - Unique locking action allows ring to stay secure, as needed
 - Ability to tighten without tools

Includes (1) Ring Holder Body, (2) Sets of 10 Mandrels, (2) Standard Cones, (2) Locking Cones, (1) Drawbar, (1) Drawbar Knob, (1) Hex Nut, and (1) GRS Hex Wrench. Mandrel Sizes: 13.5 mm, 14.5 mm, 15.5 mm, 16.5mm, 17.5 mm, 18.5 mm, 19.5 mm, 20.5mm, 21.5 mm, and 22.5 mm.

I.D. Ring Holder Parts Kit

- \$67.75 #004-707
- Replacement parts for the GRS I.D. Ring Holder (#004-735)
 - Make a complete package for an Outside Frame Assembly for I.D. Ring Holder (#004-754)

Includes (2) Sets of 10 Mandrels, (2) Standard Cones, (2) Locking Cones, (1) Drawbar, (1) Drawbar Knob, (1) Hex Nut, and (1) GRS Hex Wrench. Mandrel Sizes: 13.5 mm, 14.5 mm, 15.5 mm, 16.5mm, 17.5 mm, 18.5 mm, 19.5 mm, 20.5mm, 21.5 mm, and 22.5 mm.

Set of 10 Mandrels for I.D. Ring Holder

- \$23.35 #004-705
- Replaces original set of mandrels for the GRS I.D. Ring Holder

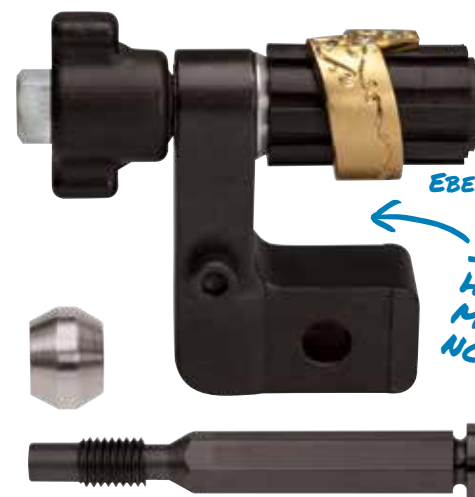

I.D. Ring Holder Expansion Kit

- \$34.95 #004-755
- Doubles the working area of the GRS I.D. Ring Holder
 - Accommodates two mandrels at once
 - Allows working on two rings at the same time or working on one wider ring
 - Used with the GRS I.D. Ring Holder (sold separately)

RING BY EBERHARD MACH
I.D. RING HOLDER + MANDRELS NOT INCLUDED



Outside Frame Assembly for I.D. Ring Holder

- \$35.05 #004-754
- Allows better clearance and more angles while working on rings
 - Set screws allow free positioning when removed or easy positioning in a vise when installed
 - Use with the I.D. Ring Holder (#004-735) or with the I.D. Ring Holder Parts Kit (#004-707)



Alexandre Ring Fixture

- Designed by world-renowned diamond setter Alexandre Sidorov
- Mounts directly to the GRS MicroBlock®
- Bell-shaped jaw attachments enhance the function of the vertical and horizontal drawbars
- Spherical base on vertical ring holder permits multi-axis movement for superior access to the work surface

Alexandre Stone Setter's Package

\$688

#003-783

Includes Alexandre Ring Fixture (#003-782): 2 bell-shaped jaw attachments, 6 button-head cap screws, 1 wrench, 1 short horizontal drawbar, 1 long horizontal drawbar, 1 vertical drawbar, 2 plastic standard cones, 2 plastic locking cones, 1 steel standard cone, 1 double-sided cone, 1 cone cover, 1 countersunk screw, 20 expanding mandrels, and 1 aluminum storage tray. Includes GRS MicroBlock® (#003-683): Vise, 4 pins, 1 wrench, 6 screws, plastic base, 1 plastic hex key, and Thermo-Loc Sample Kit.

Alexandre Ring Fixture

\$430

#003-782

Includes 2 bell-shaped jaw attachments, 6 button-head cap screws, 1 wrench, 1 short horizontal drawbar, 1 long horizontal drawbar, 1 vertical drawbar, 2 plastic standard cones, 2 plastic locking cones, 1 steel standard cone, 1 double-sided cone, 1 cone cover, 1 countersunk screw, 20 expanding mandrels, and 1 aluminum storage tray. MicroBlock® not included.



Alexandre Ring Fixture Adapter

\$74.95

#003-747

- Enables the use of Alexandre Ring Fixture (#003-782) in GRS Standard Block



SLIDE & LOCK

The Slide & Lock system was designed by JA Master Bench Jeweler Jeff Mathews to help jewelers work more efficiently. By simply opening the brass handle you can quickly reposition the height of your work for easy adjustments or to move to the next task.

- Support up to two separate tools at once
- Ergonomically designed to reduce strain and weariness in hands, neck, and back
- Positions work for viewing through microscope or OptiVISOR
- Easily slide the holder into position and lock it
- Adjust height in seconds
- Lock is easily reversed for right- or left-hand use
- Supports a maximum weight of 35 pounds

Mini

\$195

#004-758



5" OF VERTICAL TRAVEL

Original

\$225

#004-757



8" OF VERTICAL TRAVEL

Tru-Axis

Developed for use with Microscopes

This design allows the ability to maintain a set height of the Slide and Lock, enabling the Tru-Axis portion to travel up to 4" vertically without contacting the microscope.



Tru-Axis

\$375

004-759

4" OF VERTICAL TRAVEL

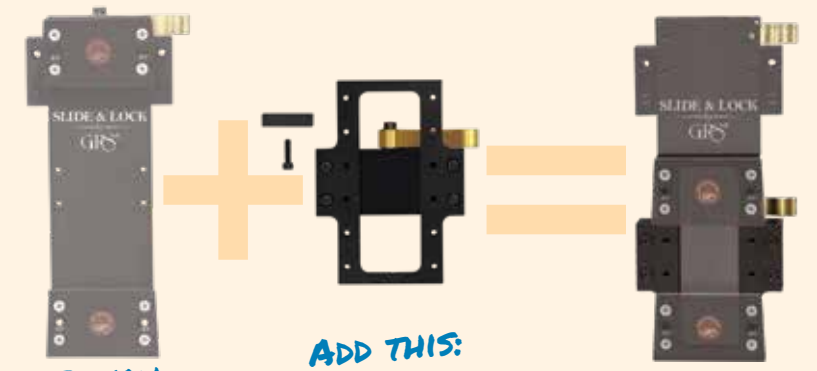

IF YOU ALREADY OWN:

Slide & Lock Original #004-757

ADD THIS:

Tru-Axis Adapter #004-753

TO GET THIS!

Slide & Lock Tru-Axis #004-759

FLEXIBILITY

Toolless height adjustment

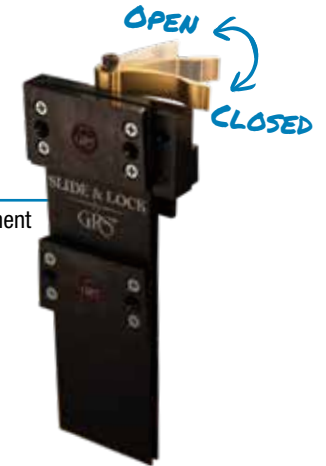

PRODUCTIVITY

Attach two tools using the GRS Fixed Mounting Plates

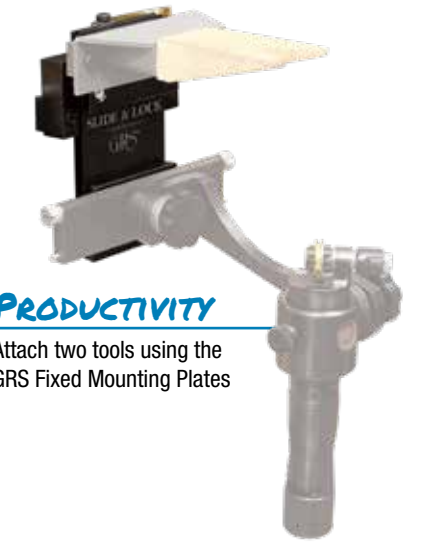

Shellac Pad

\$14.25
#004-106

- Provides small, stable surface
- Easily add shellac or other materials
- Works with vises, blocks, and the BenchMate



WORK BY
ALEXANDRE
SIDOROV

ENGRAVED FLOOR PLATE
BY MIKE DUBBER



ENGRAVED
PRACTICE PLATE
BY SERGET
MANAENKO
WITH STONE
SETTING BY
NADJA IHSEN

PitchCup

\$30.25
#004-660

- Filled with pitch that softens when heated
- Hold fragile, small, or irregular pieces
- Fits most vises, blocks, and the GRS BenchMate®
- Small, compact size

PitchCup without Pitch

\$18.65
#004-659

- Empty cup for customizable workholding material
- Fill with pitch or GRS Thermo-Loc® to use



PitchBowl

\$79.20
#003-022

- Filled with pitch that softens when heated
- Hold fragile, small, or irregular pieces
- Fits most vises and blocks
- Medium, compact size

Pitch (1 lb)

\$21.90
#002-230

- For use with PitchBowl, PitchCup, and any other appropriate workholding container

GRS® Metal Former

\$337
#004-725

- Creates "C" shapes in strips in soft metals like silver, copper, and gold
- Soft alloy material supports die pressure but does not distort engraved work
- Material can be reformed by heating, as necessary
- Form strips from 0.25" (6.35 mm) up to 1.25" (31.75 mm) wide into domed shapes
- Works for metal thickness of 0.030" to 0.080" (0.76 mm to 2.03 mm)

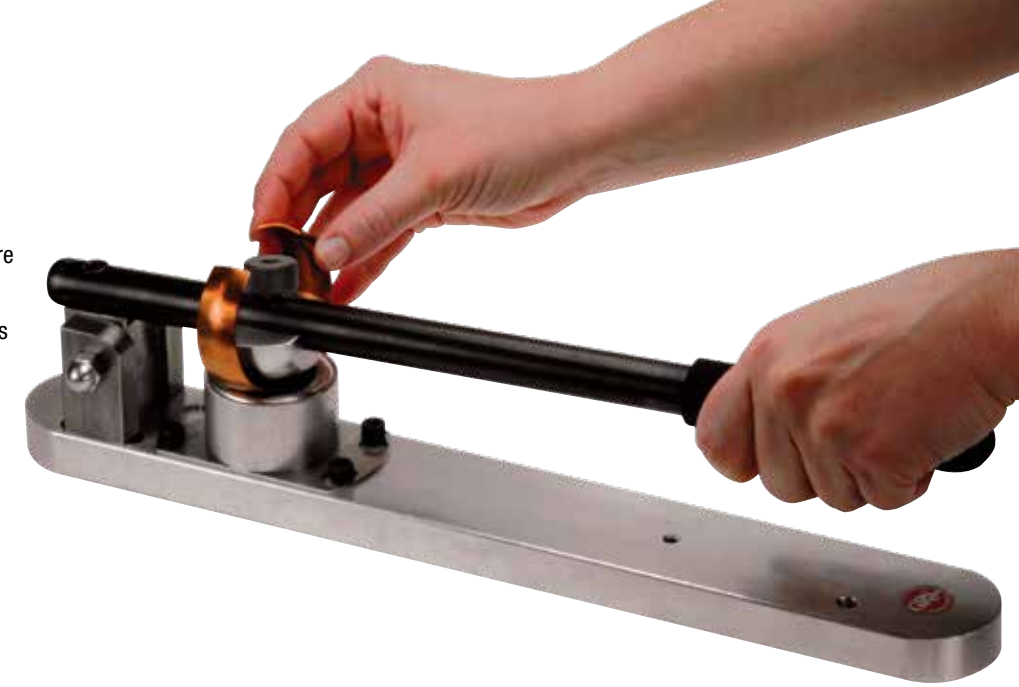

Urethane Die Cup and Flat Die Set for GRS® Metal Former

\$63.20
#004-726

- Use with non-traditional jewelry metals
- Can form some stainless steels up to 0.080" (2 mm) thick
- Create a flat form



MORE PRODUCTS
AVAILABLE ONLINE
visit grs.com

Ring Size Cutter

- Simplifies ring sizing by removing an exact amount of ring shank
- Cut is precisely to size and always parallel so soldering is neat and fast
- For gold or silver rings only

Ring Size Cutter, USA / British Model

\$338
#004-642

Includes 7 cutters from USA/British size 1/2" to 2" in 1/4" increments.

Ring Size Cutter, Metric Model

\$338
#004-643

Includes 9 cutters from 1 mm to 5 mm in 0.5 mm increments.

Replacement USA / British Cutter Kit for Ring Size Cutter

\$98.95
#004-585

Includes 7 cutters.

Replacement Metric Cutter Kit for Ring Size Cutter

\$84.05
#004-600

Includes 9 cutters.



GRAVERHONE®

Rough, sharpen, and polish high-speed steel or carbide gravers faster with the GraverHone VS. This variable-speed hone features high torque with an American-made motor promoting the highest quality and longevity.



GraverHone® VS

\$845

#003-598

- American-made motor for the highest quality and longevity
- Durable, heavy-duty unit body
- Variable speed with dual direction rotation
- 400-900 RPM



GraverHone® VS Complete GRS® Apex Sharpening System

\$1299

#003-800

- GraverHone VS features variable speed and dual direction
- Marked, color-coded dials make sharpening faster
- Easy for beginners, fast for advanced users

Includes GraverHone VS, GRS® Apex Sharpening System, GRS® Apex Fixture, GRS® Apex Post, Dual Angle Dial, Speedline Dials (90, 105, 120 degree), Diamond Wheels (260, 600, 1200 grit), and Diamond Wheel Rack.



GraverHone® VS Complete Dual Angle Sharpening System

\$1289

#003-801

- GraverHone VS features variable speed and dual direction
- Premium fixture post for Dual Angle fixture improves performance
- Create custom tool angles quickly and easily

Includes GraverHone VS, Diamond Wheels (260, 600, 1200 grit), Diamond Wheel Rack, and Dual Angle Fixture with Premium Sharpening Post.

GRS® Apex SHARPENING

CLEARLY MARKED FOR SIMPLE STEP-BY-STEP SHARPENING



LONGER FIXTURE POST EASILY ACCOMMODATES LONGER GRAVERS

GRS® Apex Sharpening System

\$325

#003-760

- Sharpen faster with step-by-step marked angles
- Premium fixture post improves stability
- Creates efficient repeatability
- Easy for beginners, fast for advanced users

Includes the GRS® Apex Sharpening Fixture, Speedline Dials (90, 105, 120 degree), Dual Angle Dial, GRS® Apex Fixture Post, and Storage Rack.



GRS®.com

Dual Angle Sharpening Fixture

\$315

#003-570

- Features an accurate and secure locating seat for a wide variety of tools
- Set elevation and rotation quickly with two degree dials



Dual Angle (Head Only)

\$282

#003-571

QC Locking Adapter Kit

\$39.80

#003-706

- Updates classic non-QC Dual Angle Fixtures immediately
- Saves money and time with this simple update
- Exclusively accepts QC Tool Holders for faster tool switching



MORE PRODUCTS
AVAILABLE ONLINE
visit grs.com

GRS® Apex Sharpening System

\$325

#003-760

- Sharpen faster with step-by-step marked angles
- Premium fixture post improves stability
- Creates efficient repeatability
- Easy for beginners, fast for advanced users



EasyGraver® Sharpening Fixtures

- Extremely easy to understand and fast to use, especially for beginners
- Saves time with easy repeatability and accuracy
- Exclusively accepts QC Tool Holders for faster tool switching

Please note that the Post Assembly (#003-502) IS NOT INCLUDED and must be purchased separately.

105°

\$155

#003-701

120°

\$155

#003-700



GRS® Apex Organizer Rack

\$27.00

#003-438

- Rack features 4 slots for GRS® Apex Speedline Dials (not included)



GRS® Sharpening Post

\$40.70

#003-769

- 80 lb magnet
- Use the included cover to dampen the strength
- Overall post height has been extended to 7" for use with longer gravers
- Post promotes more accurate, repeatable grinds



GRS® Apex Dual Angle Fixture

\$287

#003-761

- Features an updated design with familiar function
- A shorter front profile accommodates longer gravers
- Exclusively accepts QC Tool Holders for faster tool switching
- Premium fixture post improves stability



GRS® Apex Speedline Dial Set

\$86.40

#003-762

- Sharpen faster with step-by-step marked angles
- Creates efficient repeatability
- Easy for beginners, fast for advanced users



Diamond Spray

- Improves surface polishing ability
- Atomized spray bottle allows for easy application
- Perfect for a variety of gravers and tools
- For use with the GRS ceramic and cast iron laps

EXTRA FINE →

1/4 Micron

\$32.30

#002-752



FINE →

1/2 Micron

\$32.30

#002-753



MEDIUM →

1 Micron

\$32.30

#002-754



COARSE →

3 Micron

\$32.30

#002-755



1/2 Micron Diamond Powder, 5 carat (1 g)

\$21.55

#023-200

- Creates polishing surface for ceramic or cast iron laps
- Contains 5 carat (1 gram) at 1/2 micron
- Perfect for use with GRS GraverHone® and Power Hone



Cast Iron Lap, 6" (150 mm)

\$125

#002-412

- Provides a finer, longer-lasting finish
- Perfectly made for gravers and tools, especially carbides
- Both sides are prepared for sharpening, doubling the life of the wheel

1 Micron Diamond Spray (#002-754) or Diamond Powder (#023-200) recommended. Size: 6" / 150 mm.

Wheel Blank, 5" (125 mm)

\$30.20

#002-129

- Medium 5" diameter surface provides adequate space
- Precision aluminum gives a flat, even surface
- Blank surface allows for custom roughing, polishing, and more

Wheel Blank, 6" (150 mm)

\$36.95

#002-537

- Large 6" diameter surface provides more space
- Precision aluminum gives a flat, even surface
- Blank surface allows for custom roughing, polishing, and more

Ceramic Lap, 6" (150 mm)

\$313

#002-415

- The ceramic wheel is efficient yet durable with normal use
- Provides a mirror finish for brighter cuts
- Perfect for use with GRS GraverHone® and Power Hone
- Requires diamond spray or diamond powder for proper polishing

Quick Wheel Change Adapter

\$82.90

#001-838

- Replaces the standard wheel knob on the original Power Hone for quick and simple wheel changes



Wheel Storage Rack

\$24.35

#001-694

- Protect and organize up to 5 wheels
- Steel construction
- Wheels sold separately



MORE PRODUCTS AVAILABLE ONLINE
visit grs.com

Diamond Wheels, 5" (125 mm)

- Diamond wheels from GRS last for years
- Surface stays flat for improved accuracy
- Use with GRS GraverHone® and Power Hone for sharpening carbide & HSS gravers

FINE →

1200 Grit

\$99.65

#002-139

MEDIUM →

600 Grit

\$99.65

#002-055

COARSE →

260 Grit

\$110

#002-138

VERY COARSE →

180 Grit Gator

\$151

#011-194

C-MAX[®] GRAVERS

Years of development led to this tungsten carbide graver with the right blend of hardness and toughness for hand engraving and stone setting applications. Try these tools and do better work in noticeably less time.





A TOOL FOR EVERY JOB

C-Max Round Blank

1/8" Round (3.18 mm)  
\$10.25 #022-611 → 2" (50.8 MM) LONG
 USE WITH QC TOOL HOLDER FOR 1/8" ROUND (#004-873)

2.35 mm Round (3/32")  
\$6.50 #022-393 → 1.77" (45 MM) LONG
 USE WITH QC TOOL HOLDER FOR 3/32" ROUND (#004-853)

1.8 mm Round (1/16")  
\$8.95 #022-622 → 2" (50.8 MM) LONG
 USE WITH QC TOOL HOLDER FOR 1.8 MM TOOLS (#004-852)

1.8 mm 10 Pack
\$79.50 #022-780

C-Max Square Blank

3/32" (2.38 mm)  
\$19.50 #022-610 → 2" (50.8 MM) LONG
 USE WITH TRADITIONAL QC TOOL HOLDER (#004-803)

2 mm Square (5/64")  
\$19.50 #022-612 → 1.96" (50 MM) LONG
 USE WITH TRADITIONAL QC TOOL HOLDER (#004-803)

C-Max Stepped Round Graver

USE WITH QC TOOL HOLDER FOR 3/32" ROUND (#004-853)

Taper Point  0.8 mm  1.0 mm  1.2 mm  1.4 mm  1.6 mm  1.8 mm  2.0 mm  2.2 mm  **\$95.00** #022-854

 → 1.77" (44.96 MM) LONG





Set of C-Max Stepped Round Gravers

C-Max Narrow Bevel

 → 1.8" (45.72 MM) LONG

\$19.50 each







USE WITH QC TOOL HOLDER FOR 1/8" ROUND (#004-873)

90°  105°  120° 
 #022-667 #022-668 #022-669

C-Max Onglette **\$19.50 each**

USE WITH QC TOOL HOLDER FOR 1/8" ROUND (#004-873)

 → 1.8" (45.72 MM) LONG

#0  #1  #2  #3  #4  #5 
 #022-625 #022-626 #022-627 #022-628 #022-629 #022-630

C-Max Parallel Flat **\$19.50 each**

USE WITH QC TOOL HOLDER FOR 1/8" ROUND (#004-873)









 → 1.8" (45.72 MM) LONG

#38  #39  #40  #41  #42  #43  #44  #45 
 0.6 mm 0.8 mm 1.0 mm 1.2 mm 1.4 mm 1.6 mm 1.8 mm 2.0 mm
 #022-712 #022-713 #022-714 #022-715 #022-716 #022-717 #022-718 #022-719

C-Max RFF Point **\$19.50 each**

USE WITH QC TOOL HOLDER FOR 1/8" ROUND (#004-873)











 → 1.8" (45.72 MM) LONG

30°  45°  60°  75°  90°  105°  120° 
 #022-792 #022-793 #022-794 #022-795 #022-796 #022-797 #022-798

C-Max Tapered Flat **\$19.50 each**

USE WITH QC TOOL HOLDER FOR 1/8" ROUND (#004-873)









 → 1.8" (45.72 MM) LONG

#36  #37  #38  #39  #40  #41  #42  #43  #44  #45 
 0.2 mm 0.4 mm 0.6 mm 0.8 mm 1.0 mm 1.2 mm 1.4 mm 1.6 mm 1.8 mm 2.0 mm
 #022-723 #022-724 #022-725 #022-726 #022-727 #022-728 #022-729 #022-730 #022-731 #022-732

C-Max Tapered Round **\$19.50 each**

USE WITH QC TOOL HOLDER FOR 1/8" ROUND (#004-873)







 → 1.8" (45.72 MM) LONG

#50  #51  #52  #53  #54  #55  #56 
 0.2 mm 0.4 mm 0.6 mm 0.8 mm 1.0 mm 1.2 mm 1.4 mm
 #022-680 #022-681 #022-682 #022-683 #022-684 #022-685 #022-686

C-Max V-Point **\$29.75 each**

USE WITH QC TOOL HOLDER FOR 1/8" ROUND (#004-873)



60°  75°  90°  105°  120° 
 #022-615 #022-616 #022-617 #022-618 #022-619

MORE PRODUCTS
 AVAILABLE ONLINE
 visit grs.com

GLENSTEEL® GRAVERS

This special high-speed steel is offered exclusively by GRS for tough engraving and stone setting. GlenSteel is cobalt-free, eliminating the concerns of cobalt exposure during tool sharpening and use.



GlenSteel Round Blank

1/8" Round (3.18 mm)  → 2.5" (63.5 MM) LONG
\$7.50 #022-585
 USE WITH QC TOOL HOLDER FOR 1/8" ROUND (#004-873)

2.35 mm Round (3/32")  → 2" (50.8 MM) LONG
\$6.50 #022-586
 USE WITH QC TOOL HOLDER FOR 3/32" ROUND (#004-853)

GlenSteel Narrow Bevel

\$16.95 each

→ 2.3" (58.42 MM) LONG
 USE WITH QC TOOL HOLDER FOR 1/8" ROUND (#004-873)
 90°  #024-267
 105°  #024-268
 120°  #024-269

GlenSteel Onglette \$16.95 each  → 2.3" (58.42 MM) LONG
 USE WITH QC TOOL HOLDER FOR 1/8" ROUND (#004-873)
 #0  #024-220
 #1  #024-221
 #2  #024-222
 #3  #024-223
 #4  #024-224
 #5  #024-225

High-Speed Steel

In blank and pre-shaped varieties.

GRS® X-7 Graver Blank

 **\$19.95** #022-350
 This super high-speed steel is extremely hard (nearly Rockwell C70) and very wear resistant.
 Size: 0.093" x 0.001" (2.35 mm) square. Length: 2.5" (63.5 mm).

Bevel Line Gravers

Made of high-speed steel. For bead raising and material removal.

#1 HSS Bevel  **\$13.20** #002-702
 #2 HSS Bevel  **\$13.20** #002-703

GlenSteel Square Blank

Square  **\$16.95** #002-115 → 2.7" (70 MM) LONG
 USE WITH TRADITIONAL QC TOOL HOLDER (#004-803)

Flat  **\$16.95** #002-116 → 2.7" (70 MM) LONG
 USE WITH TRADITIONAL QC TOOL HOLDER (#004-803)

Blank  **\$14.95** #002-120 → 2.7" (70 MM) LONG
 USE WITH TRADITIONAL QC TOOL HOLDER (#004-803)

High-Speed Steel Gravers

Made from quality heat-treated high-speed steel.









Blank  **\$9.00** #022-340
 0.079" (2 mm) square by 2.5" (63.5 mm) long.

Flat  **\$9.85** #022-342
 0.079" (2 mm) square by 2.5" (63.5 mm) long.

Square  **\$9.85** #022-341
 0.079" (2 mm) square by 2.5" (63.5 mm) long.

Wide Blank  **\$12.10** #022-160
 0.125" (3.2 mm) square by 2.5" (63.5 mm) long.





GlenSteel Parallel Flat \$16.95 each

USE WITH QC TOOL HOLDER FOR 1/8" ROUND (#004-873) → 2.3" (58.42 MM) LONG
 #38  0.6 mm #024-237
 #39  0.8 mm #024-238
 #40  1.0 mm #024-239
 #41  1.2 mm #024-240
 #42  1.4 mm #024-241
 #43  1.6 mm #024-242
 #44  1.8 mm #024-243
 #45  2.0 mm #024-244



GlenSteel RFF Point \$16.95 each

USE WITH QC TOOL HOLDER FOR 1/8" ROUND (#004-873) → 2.3" (58.42 MM) LONG
 30°  #024-259
 45°  #024-260
 60°  #024-261
 75°  #024-262
 90°  #024-263
 105°  #024-264
 120°  #024-265







GlenSteel V-Point \$20.50 each

USE WITH TRADITIONAL QC TOOL HOLDER (#004-803)
 60°  #022-590
 75°  #022-591
 105°  #022-592
 120°  #022-593











GlenSteel Stepped Round

→ 2" (50.8 MM) LONG
 USE WITH QC TOOL HOLDER FOR 3/32" ROUND (#004-853)
 1.8 mm  1.8 mm 10 Pack 
\$7.95 #022-779
\$68.00 #022-781

GlenSteel Tapered Round \$16.95 each

USE WITH QC TOOL HOLDER FOR 1/8" ROUND (#004-873) → 2.3" (58.42 MM) LONG
 #50  0.2 mm #024-228
 #51  0.4 mm #024-229
 #52  0.6 mm #024-230
 #53  0.8 mm #024-231
 #54  1.0 mm #024-232
 #55  1.2 mm #024-233
 #56  1.4 mm #024-234

GlenSteel Tapered Flat \$16.95 each

USE WITH QC TOOL HOLDER FOR 1/8" ROUND (#004-873) → 2.3" (58.42 MM) LONG
 #36  0.2 mm #024-247
 #37  0.4 mm #024-248
 #38  0.6 mm #024-249
 #39  0.8 mm #024-250
 #40  1.0 mm #024-251
 #41  1.2 mm #024-252
 #42  1.4 mm #024-253
 #43  1.6 mm #024-254
 #44  1.8 mm #024-255
 #45  2.0 mm #024-256

Tungsten Carbide, Wood Carving Burs

In blank and pre-shaped varieties.

Tungsten Carbide Gravers

These are much harder than any tool steel but more brittle. Sharpen with a diamond wheel.

Blank  **\$10.95** #002-232
 Size: 0.083" (2.1 mm) square by 2" (50.8 mm).

Square  **\$12.95** #002-233
 Size: 0.083" (2.1 mm) square by 2" (50.8 mm).

Blank, 1/8"  **\$7.50** #022-347

Carving Bur Set

\$64.65 #022-927
 Set of 12 different sizes and shapes to make any job faster and easier to complete. 1/16" (1.6 mm) shank.



MORE PRODUCTS AVAILABLE ONLINE
 visit grs.com

NEW TRADITIONAL GRAVERS

High-speed steel. USA, Europe, and mm size noted.



NTG Knife

\$11.95 each

#K-0 N-18 1.8 mm #022-670	#K-1 N-20 2.0 mm #022-671	#K-2 N-22 2.2 mm #022-672
------------------------------------	------------------------------------	------------------------------------

K-3 N-24 2.4 mm #022-673	K-4 N-26 2.6 mm #022-674	K-5 N-28 2.8 mm #022-675
-----------------------------------	-----------------------------------	-----------------------------------

#K-6 N-30 3.0 mm #022-676	#K-7 N-32 3.2 mm #022-677
------------------------------------	------------------------------------

NTG Flat

\$11.95 each

36 N-2 0.2 mm #022-636	37 N-4 0.4 mm #022-637	38 N-6 0.6 mm #022-638	39 N-8 0.8 mm #022-639	40 N-10 1.0 mm #022-640	41 N-12 1.2 mm #022-641	42 N-14 1.4 mm #022-642
---------------------------------	---------------------------------	---------------------------------	---------------------------------	----------------------------------	----------------------------------	----------------------------------

43 N-16 1.6 mm #022-643	44 N-18 1.8 mm #022-644	45 N-20 2.0 mm #022-645	46 N-22 2.2 mm #022-646	47 N-24 2.4 mm #022-647	48 N-26 2.6 mm #022-648	49 N-28 2.8 mm #022-649
----------------------------------	----------------------------------	----------------------------------	----------------------------------	----------------------------------	----------------------------------	----------------------------------

NTG Onglette

\$11.95 each

5/0 N-5/0 1.16 mm #022-596	4/0 N-4/0 1.24 mm #022-597	3/0 N-3/0 1.35 mm #022-598	2/0 N-2/0 1.45 mm #022-599	0 N-0 1.58 mm #022-600	1 N-1 1.78 mm #022-601	2 N-2 1.94 mm #022-602
-------------------------------------	-------------------------------------	-------------------------------------	-------------------------------------	---------------------------------	---------------------------------	---------------------------------

3 N-3 2.16 mm #022-603	4 N-4 2.54 mm #022-604	5 N-5 2.74 mm #022-605	6 N-6 2.94 mm #022-606	7 N-7 3.14 mm #022-607	8 N-8 3.36 mm #022-608
---------------------------------	---------------------------------	---------------------------------	---------------------------------	---------------------------------	---------------------------------

NTG Round

\$11.95 each

50 N-2 0.2 mm #022-650	51 N-4 0.4 mm #022-651	52 N-6 0.6 mm #022-652	53 N-8 0.8 mm #022-653	54 N-10 1.0 mm #022-654	55 N-12 1.2 mm #022-655	56 N-14 1.4 mm #022-656
---------------------------------	---------------------------------	---------------------------------	---------------------------------	----------------------------------	----------------------------------	----------------------------------

57 N-16 1.6 mm #022-657	58 N-18 1.8 mm #022-658	59 N-20 2.0 mm #022-659	60 N-22 2.2 mm #022-660	61 N-24 2.4 mm #022-661	62 N-26 2.6 mm #022-662	63 N-28 2.8 mm #022-663
----------------------------------	----------------------------------	----------------------------------	----------------------------------	----------------------------------	----------------------------------	----------------------------------

MORE PRODUCTS AVAILABLE ONLINE
visit grs.com

Liner Gravers

- High carbon steel
- For shading, florentine finishing, texturing, etc.

WHAT DO THE NUMBERS MEAN?

The first number tells the spacing in thousandths of an inch when divided by 2

The second number shows how many lines are on the graver

$18 \div 2 = 9$ ← **18-10** → # OF LINES

10 Lines Spaced 0.009"

QUICKCHANGE GRAVERS

High-speed steel. USA, Europe, and mm size noted.



QC Flat

\$11.95 each

QC 36 2 0.2 mm #022-436	QC-37 4 0.4 mm #022-437	QC-38 6 0.6 mm #022-438	QC-39 8 0.8 mm #022-439	QC-40 10 1.0 mm #022-440	QC-41 12 1.2 mm #022-441	QC-42 14 1.4 mm #022-442
----------------------------------	----------------------------------	----------------------------------	----------------------------------	-----------------------------------	-----------------------------------	-----------------------------------

QC-43 16 1.6 mm #022-443	QC-44 18 1.8 mm #022-444	QC-45 20 2.0 mm #022-445	QC-46 22 2.2 mm #022-446	QC-47 24 2.4 mm #022-447	QC-48 26 2.6 mm #022-448	QC-49 28 2.8 mm #022-449
-----------------------------------	-----------------------------------	-----------------------------------	-----------------------------------	-----------------------------------	-----------------------------------	-----------------------------------

QC Onglette

\$11.95 each

QC-5/0 5/0 1.16 mm #022-396	QC-4/0 4/0 1.24 mm #022-397	QC-3/0 3/0 1.35 mm #022-398	QC-2/0 2/0 1.45 mm #022-399	QC-0 0 1.58 mm #022-400	QC-1 1 1.78 mm #022-401	QC-2 2 1.94 mm #022-402
--------------------------------------	--------------------------------------	--------------------------------------	--------------------------------------	----------------------------------	----------------------------------	----------------------------------

QC-3 3 2.16 mm #022-403	QC-4 4 2.54 mm #022-404	QC-5 5 2.74 mm #022-405	QC-6 6 2.94 mm #022-406	QC-7 7 3.14 mm #022-407	QC-8 8 3.36 mm #022-408
----------------------------------	----------------------------------	----------------------------------	----------------------------------	----------------------------------	----------------------------------

QC Round

\$11.95 each

QC-50 2 0.2 mm #022-450	QC-51 4 0.4 mm #022-451	QC-52 6 0.6 mm #022-452	QC-53 8 0.8 mm #022-453	QC-54 10 1.0 mm #022-454	QC-55 12 1.2 mm #022-455	QC-56 14 1.4 mm #022-456
----------------------------------	----------------------------------	----------------------------------	----------------------------------	-----------------------------------	-----------------------------------	-----------------------------------

QC-57 16 1.6 mm #022-457	QC-58 18 1.8 mm #022-458	QC-59 20 2.0 mm #022-459	QC-60 22 2.2 mm #022-460	QC-61 24 2.4 mm #022-461	QC-62 26 2.6 mm #022-462	QC-63 28 2.8 mm #022-463
-----------------------------------	-----------------------------------	-----------------------------------	-----------------------------------	-----------------------------------	-----------------------------------	-----------------------------------

NTG Knife

\$11.95 each

QC-K0 18 1.8 mm #022-470	QC-K1 20 2.0 mm #022-471	QC-K2 22 2.2 mm #022-472
-----------------------------------	-----------------------------------	-----------------------------------

QC-K3 24 2.4 mm #022-473	QC-K4 26 2.6 mm #022-474	QC-K5 28 2.8 mm #022-475
-----------------------------------	-----------------------------------	-----------------------------------

QC-K6 30 3.0 mm #022-476	QC-K7 N-32 3.2 mm #022-477
-----------------------------------	-------------------------------------

Stone Setter's QC Graver Kit

\$138

Includes
Onglette: 2/0, 0, 1
Flat: 37, 40, 42
Round: 50, 51, 52, 53
Knife: K1, K2

Engraver's QC Graver Kit

\$138

Includes
Onglette: 2/0, 1, 3
Flat: 37, 38, 39, 40, 42
Round: 51, 52
Knife: K1, K2

Mixed Graver Kits

A collection of gravers for stone setting and engraving.

Stone Setter's Mixed Kit

\$105

#022-525

- QC Onglette: 2/0, 1
- QC Flat: 40, 42
- QC Round: 52
- GRS Carbide: Blank (2)
- GlenSteel: Square (2)
- GlenSteel: 120°

Engraver's Mixed Kit

\$121

#022-526

- QC Onglette: 1
- QC Flat: 37, 38, 39, 40, 42
- GRS Carbide: Blank (2)
- GlenSteel: Square
- GlenSteel: 120°

Curved Liners

32-8 \$31.10 #023-236	28-10 \$29.25 #022-374	24-10 \$24.50 #002-699	20-10 \$24.50 #002-698	18-10 \$24.50 #001-389	16-10 \$23.10 #023-079	16-6 \$24.50 #002-697	14-6 \$24.50 #002-035	8-6 \$22.25 #024-075
-----------------------------	------------------------------	------------------------------	------------------------------	------------------------------	------------------------------	-----------------------------	-----------------------------	----------------------------

Straight Liners

32-8 \$27.65 #022-358	30-10 \$26.65 #022-359	28-10 \$27.85 #022-360	24-10 \$24.50 #011-026	20-10 \$24.50 #002-695	18-10 \$24.50 #002-122	16-6 \$24.50 #002-694	14-6 \$24.50 #002-693	12-8 \$19.20 #022-812	8-6 \$24.50 #022-249
-----------------------------	------------------------------	------------------------------	------------------------------	------------------------------	------------------------------	-----------------------------	-----------------------------	-----------------------------	----------------------------

BEADING TOOLS & POINTS

Beading Tools \$1.45 each

- | | |
|---------------------------------------|---------------------------------------|
| #0
0.008", 0.20 mm
#002-813-0 | #11
0.030", 0.75 mm
#002-813-11 |
| #1
0.010", 0.25 mm
#002-813-1 | #12
0.032", 0.80 mm
#002-813-12 |
| #2
0.012", 0.30 mm
#002-813-2 | #13
0.034", 0.85 mm
#002-813-13 |
| #3
0.014", 0.35 mm
#002-813-3 | #14
0.036", 0.90 mm
#002-813-14 |
| #4
0.016", 0.40 mm
#002-813-4 | #15
0.038", 0.95 mm
#002-813-15 |
| #5
0.018", 0.45 mm
#002-813-5 | #16
0.040", 1 mm
#002-813-16 |
| #6
0.020", 0.50 mm
#002-813-6 | #17
0.042", 1.05 mm
#002-813-17 |
| #7
0.022", 0.55 mm
#002-813-7 | #18
0.044", 1.10 mm
#002-813-18 |
| #8
0.024", 0.60 mm
#002-813-8 | #19
0.046", 1.15 mm
#002-813-19 |
| #9
0.026", 0.65 mm
#002-813-9 | #20
0.048", 1.20 mm
#002-813-20 |
| #10
0.028", 0.70 mm
#002-813-10 | #21
0.050", 1.25 mm
#002-813-21 |
| | #22
0.052", 1.30 mm
#002-813-22 |

Ground Point Carbide Blank

\$9.50
#022-351

Burnish Tool

\$25.00
#022-346

Diamond Point Stipple Tool

\$20.80
#002-123

Brass Rod

\$5.50
#022-159

Heat-Treated Steel Points

Create custom tools fast with these hardened points. They are easily made into special punches, hammer tools, bead raisers, prong pushers, stipple points, and more. All points are properly hardened and come in economical packages of six.

Short, Thin - 6 Pack

Diameter: 0.072" (1.8 mm). Length: 1.65" (42 mm).
\$6.50
#002-031

Short, Thick - 6 Pack

Diameter: 0.121" (3.1 mm). Length: 1.5" (38 mm).
\$10.15
#001-624

Long, Thin - 6 Pack

Diameter: 0.121" (3.1 mm). Length: 2.875" (73.025 mm).
\$12.95
#002-118

Beading Tool Set

\$24.90
#002-812
These hardened concave steel tools are made for forming beads around stones or making dot backgrounds. Set includes 12 beading tools: Size 2, 4, and 6 - 16. A #16 makes a 0.04" (1 mm) bead or dot. Tool size increases by 0.002" (0.05 mm).



JEWELRY TOOLS & BURS

Inside Ring Gravers

Curved Ring Graver

\$11.85
#022-819

Two-Curve Ring Graver

\$11.85
#022-820

Serpentine Ring Graver

\$17.25
#022-818

MORE PRODUCTS
AVAILABLE ONLINE
visit grs.com

Millgrain Tools

These tools form a uniform series of decorative beads as the wheel rolls along the edges of jewelry and other metal items.

\$14.00 each

Size 3 #024-207	Size 4 #024-494	Size 5 #022-863	Size 6 #022-856	Size 7 #022-864
Size 8 #022-865	Size 9 #022-866	Size 10 #022-867	Size 11 #024-495	Size 12 #022-868

Millgrain Tool Set

\$80.95
#022-333
Includes 6 millgrain tools: 5, 7, 8, 9, 10, and 12. Tools work almost effortlessly in GRS impact handpieces or by hand pressure.



Diamond and Stone Bur Set

\$53.95
#004-512
Set of four diamond and two stone burs especially for glass, stone, and similar materials.
Shank size: 0.0625" (1.5875 mm).



Carbide Bur Set

\$26.95
#004-511
Versatile six-piece carbide assortment for most metals, wood, and general work.
Shank size: 0.0625" (1.5875 mm).

Round Carbide Bur

1/16" (1.5875 mm) shank.

0.5 mm Round

\$5.25
#022-317

0.6 mm Round

\$4.25
#022-318

Fox Round Burs

Set of six identical burs. 3/32" (2.38mm) shank. Tungsten carbide.

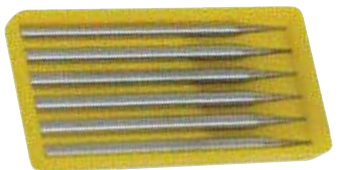

TC1-003 (3/10 mm)

\$24.35
#022-764

TC1-004 (4/10 mm)

\$27.20
#022-765

TC1-005 (5/10 mm)

\$24.00
#022-766

TC1-006 (6/10 mm)

\$23.50
#022-767

Fox Carbide Bur Set

\$18.65
#004-795
Set of four burs with 3/32" shank.
Shank size: 0.09375" (2.38 mm).



QC TOOL HOLDERS

Traditional QC

Keep tools organized and ready to use. ID: 0.136" (3.45 mm).

SINGLE	3 PACK	10 PACK
\$6.60	\$19.45	\$64.05
#004-803	#004-804	#004-806

Stainless Steel

SINGLE

\$7.95

#004-803-SS

Bronze

SINGLE

\$7.50

#004-803-BR

3/32" Round

Made for 3/32" (2.38 mm) round shank tools.

SINGLE	3 PACK	10 PACK
\$7.00	\$20.55	\$67.80
#004-853	#004-854	#004-855

Soft-Hit QC

Get a softer energy transfer for reduced tool stress, decreased vibration, and better control with fine work. For Monarch, 901, Magnum, or System 3 handpieces only. ID: 0.136" (3.45 mm).

3 PACK ONLY

\$36.95

#004-870

1.8 mm Round QC

This QC Tool Holder from GRS is the perfect fit for 1.8 mm (0.071") tools like the C-Max Round Blank 1.8 mm graver (#022-622). For even more convenience, use this QC Tool Holder with the GRS EasyGraver Sharpening Fixture (#003-700).

SINGLE	3 PACK	10 PACK
\$6.45	\$18.95	\$62.45
#004-852	#004-871	#004-872

Extra Length QC

Extends tool length by 1/2" (12.7 mm) more than traditional style. ID: 0.136" (3.45 mm).

SINGLE	3 PACK	10 PACK
\$13.15	\$38.70	\$128
#004-856	#004-857	#004-858

Blank QC

Made for use customization, this blank holder has a center-drilled pilot hole.

SINGLE	3 PACK	10 PACK
\$7.90	\$23.10	\$77.00
#004-848	#004-859	#004-860

1/8" Round QC

Made for 1/8" (3.175 mm) round shank tools.

SINGLE	3 PACK	10 PACK
\$5.80	\$17.00	\$56.00
#004-873	#004-874	#004-875

Bronze QC for 1/8" Round

This tool holder is perfect for all 1/8" (3.175 mm) shank tools.

SINGLE
\$7.50
#111-541



Combination Tool Carousel

\$43.35

#011-193

- Store up to 70 tools in a compact space
- Four removable QC Tool Trays for easy portability
- Spins for easy access

QC Tool Trays, Set of 4

\$11.40

#011-336

- Each tray holds up to 10 tools
- Designed for use with GRS QC Tool Holders
- Four colors for better organization of tools



KEEP UP TO 120 TOOLS ORGANIZED

QC Storage System

\$52.95

#011-219

- Includes color-coordinated trays and collars for better organization
- Conveniently stores up to 120 tools
- Angled tray storage for easier access



QC Storage Tray Set

\$35.65

#011-384

- Each tray holds up to 10 tools
- Designed for use with GRS QC Tool Holders
- Twelve colors with coordinating collars for better organization of tools

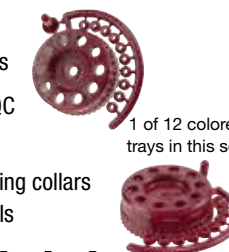

The QC Storage System (#011-219) and the QC Storage Tray Set (#011-384) include one tray in each color.

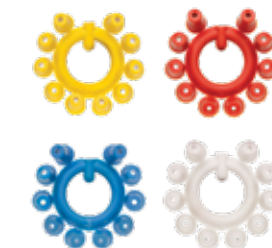

BPE Rubber Finger Protectors

\$16.80

#011-477

- Ease finger stress
- Slide on over the end of the graver to give fingers a soft rubber rest
- Set of 40 rubber finger protectors



Graduated Length QC Handles

- Durable fiber-reinforced thermoplastic and stainless steel for long-term use
- Allows extended use of tools to save money
- Comfortable knob shape provides comfort

Graduated Length QC Handle Set
Includes 2", 2.25" and 2.50 (50, 57, and 64 mm) and tray

\$56.20

#004-934

ALSO AVAILABLE SEPARATELY

QC Long Handle
Includes 2.50" (64 mm) handle.

\$17.90

#004-931

QC Medium Handle
Includes 2.25" (57 mm) handle.

\$17.90

#004-932

QC Short Handle
Includes 2" (50 mm) handle.

\$17.90

#004-933



CHROMEBOOK ENGRAVED BY ANNELESE NARCISI

Graver and Handle Kit — C-Max® Burin

\$56.00

#044-504

- Tungsten carbide graver made for hand engraving, especially intaglio printmaking
- Diameter: 0.125" (3.17 mm)
- Length: 3" (75 mm)



Thermo-Loc® Handles

\$15.15

#004-800

- Similar feel to wood handles
- Virtually unbreakable
- Comes with a Thermo-Loc core to hold tools

Adjustable Graver Handle Set

\$48.00

#004-670

- Adjust graver length for added comfort and accuracy
- Made from aircraft-grade aluminum in three colors
- Half-flat handle



Multi-Purpose Tool Holder

\$11.30

#002-704

- Comfortable wooden knob with overall length of 3.25" (83 mm)
- Collet allows diameters up to 0.125" (0.03 mm)
- Holds beading tools, prong pushers, and other tools

GRS® Hand Chuck

\$44.50

#004-000

- Comfortable shape and 2" length makes working easier
- Hardened and ground steel chuck is durable
- Jaws feature V-notch for a superior grip
- Great for holding beading tools, prong pushers, and other tools



GRS® QC Handle

\$34.95

#004-805

- Ergonomic rubber knob shape for comfortable use
- QuickChange capability for faster tool switching
- Durable materials for long-term use
- Holds beading tools, prong pushers, gravers, and more



Sam Alfano Chisel Handle

\$42.50

#111-540

- Durable bronze and walnut give the handle a beautiful look
- Quality wood provides a nice feel and comfortable handle



Bronze QC Tool Holder for 1/8" Round

SINGLE

\$7.50

#111-541



Flat

\$53.00

#011-470



Round

\$53.00

#011-471

GRS® Chasing Hammer

- Heat-treated high-alloy tool steel for durability
- Hand polished for smooth results
- Finely balanced for precision work

Set (One of Each)

\$103

#011-472

Set of two hammers, one round end and one flat end.



GRS® QC Chasing Tool Holder

\$26.65

#044-220

- Features QC for fast tool switching
- Machined steel for durability
- Perfect for hammer and chisel work

Learn Old School Hammer & Chisel Engraving DVD

\$60.00

#024-475

- Over one hour of instruction and learning time
- Features traditional hammer and chisel techniques
- Taught by respected master engraver Sam Alfano

DVD, 80 mins. Alfano Hammer & Chisel Kit sold separately (#022-587).

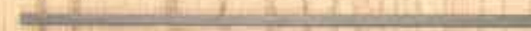

Sam Alfano Hammer & Chisel Complete Kit

\$425

#022-588

- Practice plates in brass and steel for a multiple cutting surfaces
- 5 gravers and QC Tool Holders for various techniques
- Quality wood handles and chasing hammer for precision work
- Sharpening stones and guide for hand sharpening
- Includes DVD with instructional video for a better learning experience

Includes Learn Old School Hammer & Chisel Engraving DVD, GRS Chasing Hammer, (2) Sam Alfano Chisel Handle, (5) Bronze QC Tool Holders for 1/8" Round, #36 Glensteel Tapered Flat, #37 Glensteel Tapered Flat, #38 Glensteel Tapered Flat, #39 Glensteel Tapered Flat, 90° GlenSteel RFF Point, 3/32" x 3/32" x 4" Tool Steel, 2" x 2" Square Practice Plates: (5) Mild Carbon Steel 16 ga., (2) Square Practice Plates, (6) Half-Hard Brass 16 ga., Fine Pad on 6" x 3/4" Stone, and Double-Sided 3/4" x 4" Super Fine Stone.

Sam Alfano Hammer & Chisel Kit

\$385

#022-587

- Practice plates in brass and steel for a multiple cutting surfaces
- 5 gravers and QC Tool Holders for various techniques
- Quality wood handles and chasing hammer for precision work
- Sharpening stones and guide for hand sharpening

Includes GRS Chasing Hammer, (2) Sam Alfano Chisel Handle, (5) Bronze QC Tool Holders for 1/8" Round, #36 Glensteel Tapered Flat, #37 Glensteel Tapered Flat, #38 Glensteel Tapered Flat, #39 Glensteel Tapered Flat, 90° GlenSteel RFF Point, 3/32" x 4" Tool Steel, 2" x 2" Square Practice Plates: (5) Mild Carbon Steel 16 ga., (6) Half-Hard Brass 16 ga., Fine Pad on 6" x 3/4" Stone, and Double-Sided 3/4" x 4" Super Fine Stone.



Leica® A60 with 0.63x Objective Lens + Adapter for Acrobat® Classic Stand

\$2050

#003-658

- FusionOptics provides a larger field of view and depth of focus
- Allows easier handling, less refocusing, and time savings
- Working distance ensures great freedom of movement
- Includes A60 0.63x objective lens and adapter for the GRS Acrobat® Classic



Acrobat® Versa Stand for Leica® A60

\$586

#003-635

- Redesigned Acrobat specifically for the Leica A60 microscope
- Features a rigid frame that makes positioning easy
- Magnetic document holder and ergonomic handles improve the optical experience
- Accepts 15.8mm (5/8") pin style microscopes

Mounting base, post, stand, and primary document holder included. Leica® A60 microscope, secondary document holder, camera mount, and Optia® LED Ring Light sold separately.



Leica® A60 "F" Value Package

\$2035

#003-654

- FusionOptics provides a larger field of view and depth of focus
- Allows easier handling, less refocusing, and time savings
- Working distance ensures great freedom of movement
- Includes 0.63x objective lens and flex-arm style stand

Meiji EMZ-5 for Acrobat® Classic Stand

\$1595

#003-563NFB

- Magnifies up to 22.5x for a clear view of surfaces and tools
- Stereo zoom microscope body allows for proper depth perception and three-dimensional view
- Provides a working distance of 5.8" (148 mm)
- Includes 0.50x objective lens



Meiji EMZ-5 for Acrobat® Classic Stand (Eyeglasses Version)

\$1695

#003-563NFB-G

Acrobat® Classic Microscope Stand

\$610

#003-630

- Flexible solution for the Meiji EMZ-5 Microscope for Acrobat (#003-563NFB)
- Quickly adjusts vertically and horizontally to a variety of workholding situations
- Swings away to either side when not in use
- Arm resistance can be adjusted as desired from free to locked
- Built-in headrest reduces neck and back strain
- Accepts 84 mm microscopes

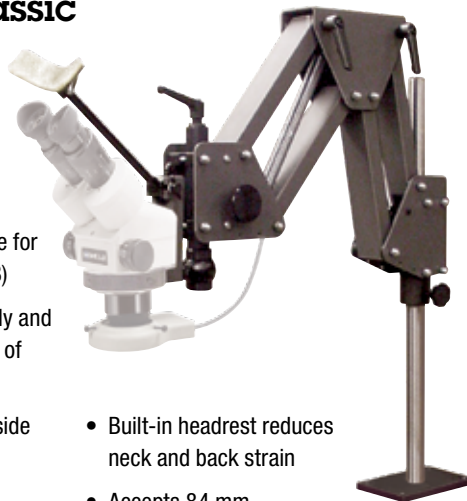

Leica® A60
ACROBAT® VERSA

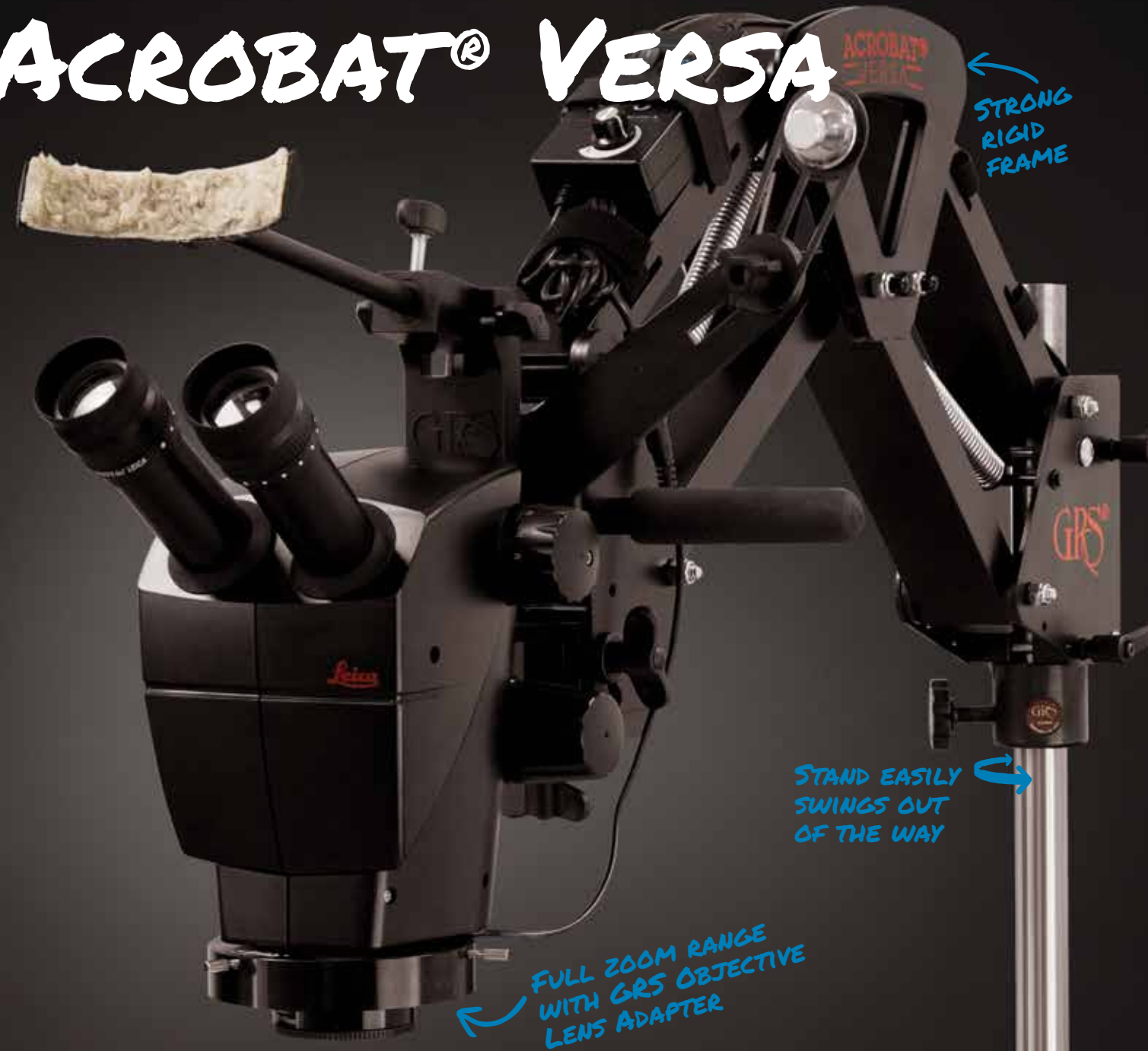

Acrobat® Versa + Leica® A60 Complete Package with 0.63x Objective Lens

\$2495

#003-657

- FusionOptics provides a larger field of view and depth of focus
- Allows easier handling, less refocusing, and time savings
- Working distance ensures great freedom of movement

Includes the Acrobat® Versa stand, Leica® A60 microscope, Optia® LED light and control, mounting base, post, and primary document holder.



ACROBAT® VERSA & CLASSIC



Headrest Kit for Leica®

\$105
#003-660

- Attaches to the Leica A60 to follow the movements of the scope
- Promoting proper ergonomics
- Leica A60 not included



GRS® Logo Dust Cover for Acrobat® Versa / Leica®

\$15.75
#003-729

- Protects microscope from dust



Double Document Holder Kit for Acrobat® Versa

\$69.95
#003-632

- Easily assembles to the Acrobat Versa to provide a secondary holder
- Provides hands-free holding of customer invoices, inspiration, examples, etc.
- 14 lb. magnet
- Not compatible with Acrobat Classic

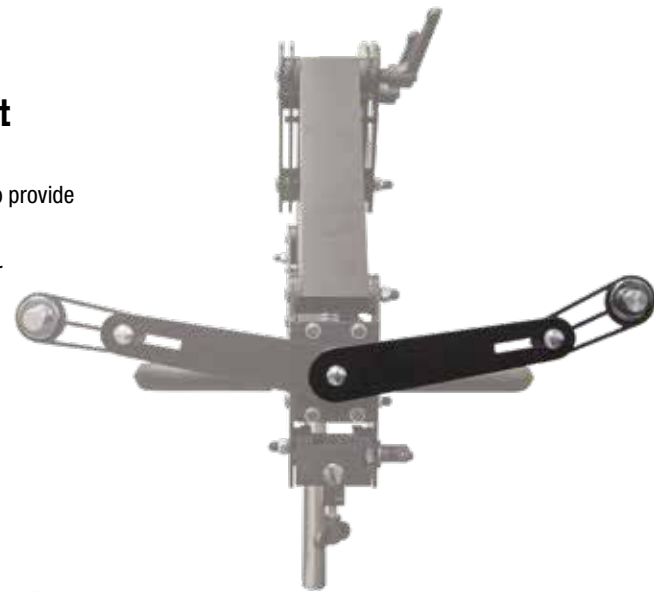

Adapter Kit for Acrobat® Classic Stand

\$193
#003-599

- Allows mounting of microscopes that have a 5/8" (15.8 mm) mounting pin



ACROBAT® VERSA



Camera Mount for Leica®

\$247
#003-728

- Provides a lightweight camera-mounting solution
- Allows for a wide range of position options
- For use with A60 Complete Headrest Kit (#003-660)
- For use with 1/4-20 threads

Only available for use with A60 Complete Headrest Kit (#003-660). Camera not included.



Objective Lens Adapter for Leica®

\$82.50
#003-727

- Enables full zoom range when using an objective lens
- Provides the ability to add a lens for the full value of the 6:1 zoom range
- Solid, durable construction



MORE PRODUCTS
AVAILABLE ONLINE
visit grs.com

Objective Lenses

Adding an objective lens enables increased working distance and provides a greater field of view.

0.50x

\$182
#003-850

- Zoom Range: 2.5x - 15x
- Working Distance: 200 mm (7.8")
- Field of View: 90 mm - 15 mm

0.63x

\$182
#003-863

- Zoom Range: 3.15x - 18.9x
- Working Distance: 155 mm (6.1")
- Field of View: 70 mm - 11.7 mm

0.75x

\$182
#003-875

- Zoom Range: 3.75x - 22.5x
- Working distance: 130 mm (5.1")
- Field of View: 60 mm - 10 mm



GRS® Horizontal "F" Mount

\$97.90
#023-238

- Ultra-sturdy mounting solution
- Great alternative to the clamp-style mount
- Easily secures the flex-arm stand to a bench top

ACROBAT® CLASSIC ACCESSORIES

GRS® Ball Pivot Camera Mount for Acrobat® Stand

\$316.98

#003-678

- Attaches to either side of the GRS Acrobat Stand
- Provides a lightweight mount without adding length to the focus block
- Allows a wide range of positioning options with the installed RAM ball mounting components
- For cameras with 1/4-20 threads

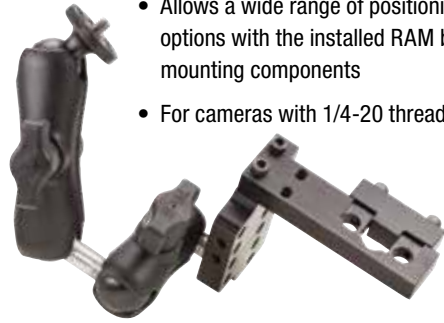

MICROSCOPE NOT INCLUDED

Utility Shelf

\$160

#003-680

- Mounts on a GRS Microscope stand or a 1.125" diameter post
- Surface area measures 16" x 11.5"
- Made from solid 1/4" aluminum with a tough, textured, powder-coated finish
- Locks into any position or rotates freely



Meiji Objective Lens

0.30x

\$163

#003-591

- Zoom Range: 2.1x - 13.5x
- Working Distance: 251 mm (9.9")
- Field of View: 109 mm - 17 mm



0.50x

\$163

#003-567

- Zoom Range: 3.5x - 22.5x
- Working Distance: 148 mm (5.8")
- Field of View: 65.7 mm - 10.2 mm

0.75x

\$172

#024-131

- Zoom Range: 5.25x - 33.75x
- Working Distance: 97 mm (3.8")
- Field of View: 43.8 mm - 6.8 mm

Utility Shelf Bracket Kit for Flat Mount

\$43.35

#003-686



Microscope Lights

Optia® LED Ring Light

- Extra-bright circular LED
- Provides natural spectrum light with adjustable intensity
- Fits most microscopes



115 V

220 V

\$215

\$262.50

#024-290

#024-290-220

Fluorescent Microscope Ring Light

- Extra bright circular fluorescent bulb
- Gives cool, glare-free illumination
- Fits GRS Meiji microscopes and many others



115 V

230 V

\$252

\$378

#022-268T

#022-268T-220

Replacement Bulb

\$56.05

#022-338



BPE LED Lights

\$137

#011-478

- Provides a bright, flexible light source
- Arms offer four points of ball-joint articulation for maximum flexibility
- Two mounting options allow the lights to be installed in multiple locations

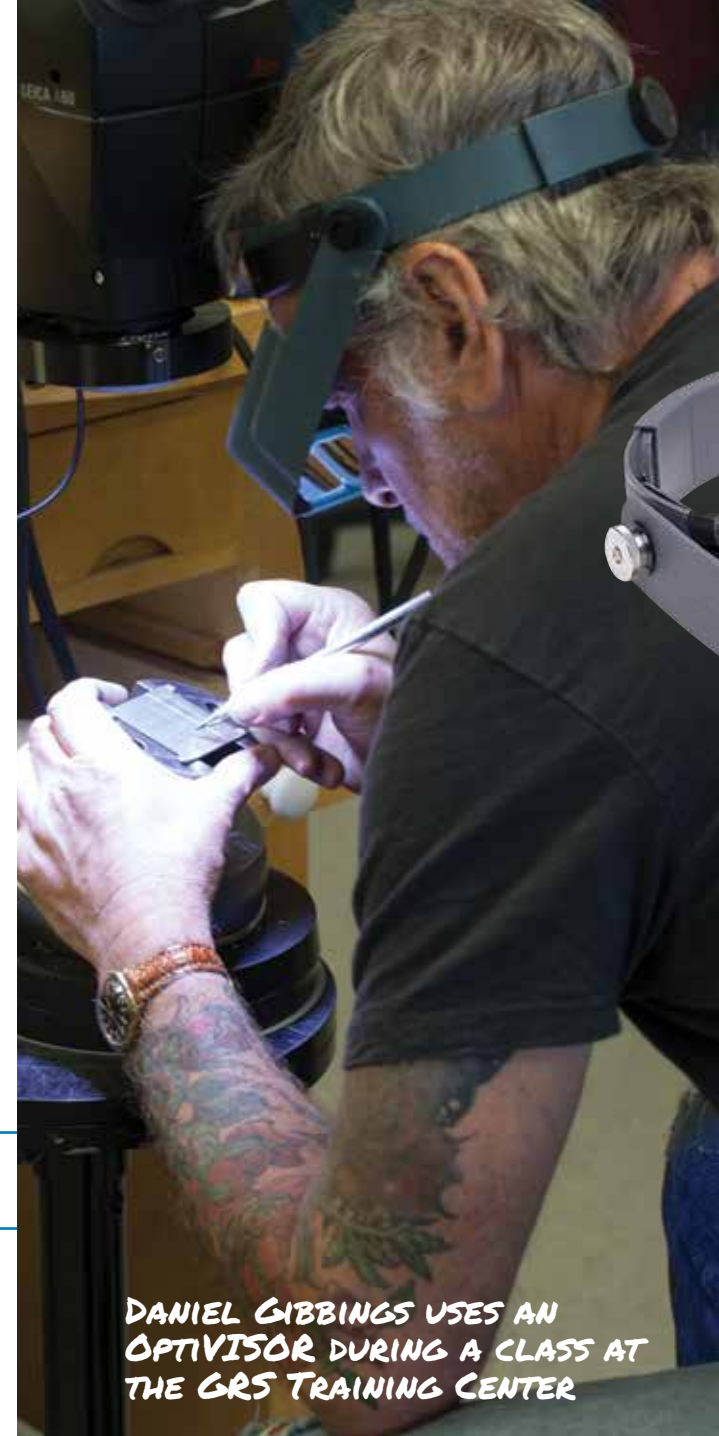

DANIEL GIBBINGS USES AN OPTIVISOR DURING A CLASS AT THE GRS TRAINING CENTER

OptiVISOR

- Helps users see work better
- Features ground plastic lenses and an adjustable headband
- Includes special kit for changing the position of each lens



#3 (1.75x)

\$47.00

#002-710

#5 (2.50x)

\$47.00

#002-711

#7 (2.75x)

\$47.00

#002-712

OptiVISOR Replacement Lenses

#3 (1.75x)

\$31.15

#002-965

#5 (2.50x)

\$31.15

#002-966

#7 (2.75x)

\$31.15

#002-967

Optiloupe Kit for OptiVISOR

\$19.70

#022-119

- Adds an extra 2.5x to the OptiVISOR
- Swings away when desired
- Helps users see work better



Chrome Finish Eye Loupe

\$19.60

#011-380

- High-quality optics
- Allows close inspection of tools and work
- 10x triplet 18 mm lens
- Chrome finish, leather case



Geometric Template

\$14.00

#022-890

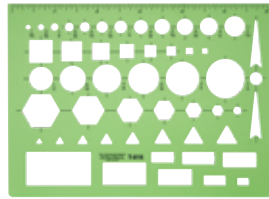

Layout Template

No. T41

\$6.70

#022-049

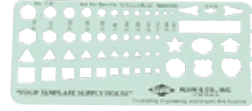

Design and Layout Surface

\$58.60

#003-730

- Multi-purpose work surface that mounts into a GRS vise
- 6-inch diameter provides a large work surface
- Great for layout under scope



Transfer Wax

\$15.25

#002-709



- Blend of pure beeswax, mutton tallow, emu oil, and other oils and waxes
- Used for layouts, replicating, and reversing engraved designs

Molding Clay

\$7.05

#022-290



- Medium light gray reduces eye fatigue while working
- Securely holds fragile pieces
- Can be used to reduce surface glare on metal pieces

Chinese White

\$16.25

#002-708



- Puts a dull water-based film on most surfaces for drawing or tracing designs

Ring Layout Mandrel

\$56.95

#023-280

- Designed to help artists efficiently lay out rings
- Mandrel's circumference is measured into 10° intervals
- Markings at 0°, both 90°, and 180°
- Accurately split a ring into quadrants for more precise spacing



BPE Ceramic Tip Polishing Tools

- Refine relief engraving with these Ceramic Polishing Tools
- Clean corners, hone edges, and smooth shapes
- Available in three grits: 180, 600, and 1000

\$43.60 each



Yellow, 180 Grit

#011-473



Black, 600 Grit

#011-474



White, 1000 Grit

#011-475

AlexTools Precision Dividers \$168 each

- Precision dividers from renowned stone setter Alexandre Sidorov
- Designed for setters and engravers who require fine measurements and comfortable use
- Fixed legs ensure precise movements and prevent any side deflection
- Change or customize your 1.6 mm carbide tips at any moment with a hex key



75 mm

#023-117

85 mm

#023-118



Starrett 3" Divider

\$75.60

#022-156

- Rugged and dependable Starrett product
- For design layouts, borders, circles, and distances between centers on rings, barrels, receivers, and more



Graphgear 500 Pencil

\$16.70

#024-007

- Perfect for precision and light lines
- Mechanical, 0.3 mm

Scribe Tool

\$11.15

#022-140

- Carbide tip makes stipple design transfer and marking layouts quick and easy



TAP Magic Graver Lube Kit

\$11.90

#004-638

- Extends graver life and brightens cuts
- Sharpen gravers less often and work will look better
- Contains 4 fluid ounces of lubricant



Scribe Kit

\$17.95

#022-584

- Perfect for scrimshaw
- Handle and removable point excellent for scribing layouts on a workpiece
- Comes with six identical points



Polishing Paper

\$3.50

#022-337



- Super-fine polishing paper leaves a bright, smooth surface finish

- 30 micron
- 8.5" x 11" sheet

Wet Dry Sanding Paper

220 Grit

\$1.70

#022-289

320 Grit

\$1.70

#022-147

400 Grit

\$1.70

#022-146

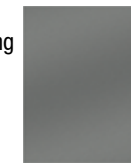

- Made for deburring and finishing your engraved pieces
- 8.5" x 11" sheet

Spray Lacquer

- Protects brass, silver, or other solid or plated materials from tarnishing or rusting

- Available in three finishes



Special Gold Colored

\$22.05

#024-026



Outdoor Clear

\$20.95

#024-027



Clear

\$20.95

#024-025

Alumilite Super Plastic Casting Resin

- Great for making castings of finished work

White, 28 oz

\$44.05

#022-067

Tan, 28 oz

\$41.95

#022-068



Alumilite Silicone RTV Quick-Set Mold-Making Rubber Kit

\$32.95

#022-279

- Makes accurate molds of engraved items, sculptures, jewelry, scrimshaw, wood carvings, and collectible coins

Includes 1 pound of base and catalyst.

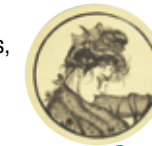

CASTING BY BOB FINLAY

Renaissance Wax Polish

\$21.55

#024-001

- Contains refined waxes blended to a formula used by museum and restoration specialists
- Revives and protects leather, metals, marble, ivory and many other surfaces



GRS® Apron

\$25.00

#022-516

- Adjustable neck strap, three large front pockets, ties at waist
- Machine washable
- 65% polyester, 35% cotton
- Available in black

1" x 2" Practice Plates

Use these quality materials to practice engraving and stone setting.

- 416 Stainless Steel, 9 ga.**
\$9.95
#011-363
- Half-Hard Brass, 12 ga.**
\$5.30
#011-347



1" x 2" Stone Setting Plates for 4 mm Stones

Use these quality materials to practice stone setting.

- Half-Hard Brass, 5 Holes 12 ga.**
\$11.25
#011-335S
- Half-Hard Brass, 8 Holes 12 ga.**
\$13.00
#011-335-8
- Half-Hard Brass, 15 Holes 12 ga.**
\$10.85
#011-335



2" x 2" Square Practice Plates

Use these quality materials to practice your engraving and stone setting.

- Half-Hard Brass, 16 ga., 3 Pack**
\$16.95
#001-804
- Copper, 16 ga., 3 Pack**
\$10.00
#003-594
- Mild Carbon Steel, 16 ga., 5 Pack**
\$9.00
#001-638
- Cronite, 18 ga.**
\$4.00
#022-287



2" x 4" Practice Plate

Use these quality materials to practice your engraving and stone setting.

- Copper, 16 ga.**
\$7.55
#003-361
- Cronite, 18 ga.**
\$6.00
#022-907

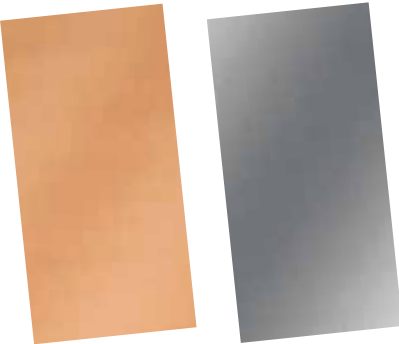

2.5" x 8" Stainless Steel Project Plate

\$9.80
#024-030
This 410 series stainless steel plate can be used for making bracelets, practice gun plates, and many other small project pieces.



Watch Bezel Practice Blank for 2 mm Stones

\$46.95
#011-383



Firearm Practice Plates

Perfect for learning how to lay out designs and borders before cutting the real thing.

- Remington Practice Plate**
\$8.25
#024-013
- Revolver Cylinder**
\$23.15
#011-423
- Practice Floor Plate, Flat Shape M70 Style, 12 ga.**
\$7.25
#022-565
- Practice Floor Plate, Formed Shape M70 Style, 12 ga.**
\$8.25
#022-565-F
- Oval Grip Practice Plate, Flat**
\$7.50
#022-566
- Oval Grip Practice Plate, Domed**
\$6.05
#022-566-F

Channel Practice Ring

- Stainless Steel Ring for 3 mm Square Stones**
\$31.50
#004-401SS
- Brass Ring for 3 mm Square Stones**
\$17.40
#004-401
- Brass Ring for 3 mm Round or Square Stones, 20 Holes**
\$16.15
#004-489

General Practice Rings

- Domed 5.5 mm Wide Brass Ring**
\$4.00
#004-300
0.22" (5.58 mm) wide.
- Domed 5.5 mm Wide Brass Ring, 5 Pack**
\$16.95
#001-953
0.22" (5.58 mm) wide.
- Flat Chamfered 4.5 mm Wide Brass Ring**
\$6.00
#004-490
0.170" (4.5 mm) wide.
- Flat Chamfered 5 mm Wide Brass Ring**
\$6.05
#004-412
0.197" (5 mm) wide.

Engravable Key Tags

- Stainless Steel Style 1, Oval**
\$7.15
#003-300
- Stainless Steel Style 2, Rounded Teardrop**
\$7.15
#003-301
- Stainless Steel Style 3, Rounded Rectangle**
\$8.50
#003-334
- Brass Style 3, Rounded Rectangle**
\$6.50
#003-304
- Nickel Silver Style 3, Rounded Rectangle**
\$4.00
#003-305
- Stainless Steel Style 4, Circle**
\$7.15
#003-335
- Brass Style 4, Circle**
\$4.15
#003-302
- Nickel Silver Style 4, Circle**
\$3.75
#003-303

Pavé Practice Ring

- Brass Ring for 2.4 mm Stones, 6 Holes**
\$45.05
#011-366
- Brass Ring for 1.5 mm Stones, 10 Holes**
\$24.10
#011-379

MORE PRODUCTS AVAILABLE ONLINE
visit grs.com

Loose Cubic Zirconia Stones

Each comes in pack of 20.

- 1.5 mm Round**
\$11.25
#023-005
- 2.0 mm Round**
\$11.80
#023-006
- 2.4 mm Round**
\$13.35
#023-007
- 3.0 mm Round**
\$15.95
#023-008
- 3.0 mm Square**
\$34.30
#023-004
- 4.0 mm Round**
\$24.30
#023-009
- 5.0 mm Round**
\$33.50
#023-010



The Art of Engraving
\$49.95
 #002-164
 Hardcover, 196 pages.



Basic Engraving
\$22.95
 #022-192
 Spiral bound, 45 pages.



Engraving Methods and Techniques
\$47.15
 #011-483
 DVD, 4 hours.

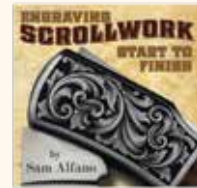

Engraving Scrollwork Start to Finish
\$53.30
 #023-502
 DVD, 75 mins.



Engraving the Meek Squirrel with Jake Newell
\$20.45
 #023-111
 DVD.



Learn Old School Hammer & Chisel Engraving DVD
\$60.00
 #024-475
 DVD, 80 mins.



Easy Step-by-Step Graver Sharpening
\$47.15
 #011-484
 DVD, 120 mins.



The Expert's Guide To Graver Sharpening
\$49.95
 #022-375
 DVD, 67 mins.

GRAVER SHARPENING



Beginning Scrimshaw
\$41.00
 #023-104
 DVD.

SCRIMSHAW



Western Bright Cut Engraving
\$129
 #023-093
 DVD (2-Disc Set), 4.5 hours.



Cowboy Crafts: Complete 3-Disc Set
\$180
 #022-133-DVD
 DVD (3-Disc Set), 7 hours.



Up-Close with Sam Alfano
\$45.00
 #011-381
 DVD, 60 mins.

JEWELRY + ENGRAVING

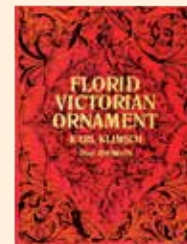

Florid Victorian Ornament
\$15.70
 #002-720
 Paperback, 102 pages.



Lettering Techniques for Hand Engravers
\$53.30
 #023-116
 DVD, 80 mins.

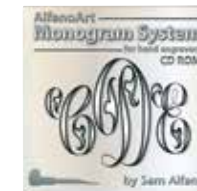

AlfanoArt Monogram System
\$57.20
 #023-109
 CD-ROM.

CD-ROM

LETTERS, MONOGRAMS + ORNAMENTS



Pavé by Alexandre, 2nd Edition
\$125
 #023-195
 Hardcover, 184 pages.



Diamond Setting Bead and Bright Cut
\$29.75
 #011-482
 DVD.

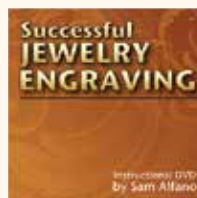

Successful Jewelry Engraving
\$53.30
 #022-855
 DVD, 120 mins.



Setting Repair
\$36.75
 #024-083
 Paperback, 143 pages.

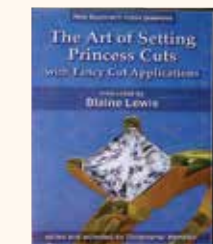

The Art of Setting Princess Cuts
\$179
 #022-922
 DVD, 150 mins.



Bezel and Flush Setting
\$179
 #022-548
 DVD, 150 mins. Includes 2 practice mountings, 2 sets of practice stones, 1 GRS hard steel point, burnisher, and templates.



Il Grande Libro Delle Incisioni
\$118
 #022-845
 Hardcover, 587 pages.



Firmo and Francesca Fracassi
\$60.00
 #023-069
 Hardcover. 236 pages.



Ornate Scrollwork & Ornamental Design
\$74.99
 #024-496
 Paperback, 100 pages.

ENGRAVING REFERENCE

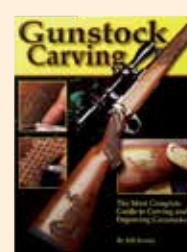

Gunstock Carving
\$20.95
 #022-529
 Paperback, 96 pages.



Carving Scrolls
\$40.95
 #022-932
 DVD (2-Disc Set).



Wood Finishing
\$25.60
 #024-012
 DVD, 67 mins.

WOODCARVING

HOW TO ORDER

Give Us a Call

Call our dedicated sales staff for assistance with any order. When ordering by phone, please have the item number, product name, and payment information ready to expedite your order.

Call Monday – Friday,
8 a.m. – 5 p.m. CST

Toll-Free:
620-343-1084

Shop Online

For a comprehensive look at all the tools GRS offers or to order online, visit our website any time. Payments by AmEx, Discover, MasterCard, and Visa are accepted.

Visit Us Online:
GRS.COM

Postal Mail or Fax

Save money on shipping to the contiguous 48 states by prepaying for orders with a check or money order.

Visit [grs.com/mailorder](https://www.grs.com/mailorder) to download the form. Then simply print and follow the instructions on the form to avoid any delay in shipping. You may send your order via postal mail or fax it in.

Mail order to:
GLENDO LLC
900 OVERLANDER ROAD
EMPORIA, KS 66801

Fax:
620-343-9640



**AUTHORIZED DEALERS
REPRESENT OUR PRODUCTS IN
OVER 100 COUNTRIES. VISIT
GRS.COM/DEALERS TO FIND
THE DEALER NEAREST TO YOU.**

Shipping Methods

Next day or second day orders placed by 12 p.m. CST generally ship same day; ground service normally ships within two business days. Shipping may be delayed if items are out of stock.

FedEx: Standard overnight, Two day, and Ground service.

UPS: One business day, Two business day, and Ground service.

United States Postal Service

Please note: All orders over \$500 require a signature.

Our Gift to You:

FREE SHIPPING

Take advantage of free ground shipping to the 48 contiguous United States, if prepaid by check or money order.

Shortage, Damage & Misshipment Claims

Shortage claims must be made within ten business days after receipt of shipment. Please inspect the package thoroughly and report any damage before you sign for it. Discuss damages with the carrier as soon as possible. To establish a claim on goods improperly shipped or damaged, you must notify GRS within five days after receipt of the goods. After five days, notifications will be treated as normal returns.



Gift Certificates

Need the perfect gift? Ask your representative about purchasing a gift certificate in any denomination of your choice. Certificates expire one year after purchase. No hidden fees.

GRS® Product Warranty

GRS manufactured products are warranted for two (2) full years against defects in material and workmanship. Any such defect will be repaired by Glendo once the item is sent prepaid freight to Glendo in Emporia, Kansas. After servicing, Glendo will pay ground freight charges to the customer's address. Shipping damage, abuse, and normal wear and tear are not covered by this warranty. Customers must call to receive a Return Authorization (RA) number before returning any item. For items not purchased directly from Glendo LLC, contact your selling dealer.

Repairs

Call 620-343-1084 for repair information.

Non-GRS® Product Warranty

Non-Glendo/GRS manufactured (vendor supplied) items are warranted by the original manufacturer. From date of purchase:

- NSK products: 90 days
- Silenaire Compressors: 1 year
- California Air Compressors: 1 year
- Fluorescent Ring Lights: 1 year

Pricing

Availability and prices are subject to change. All prices are in US dollars.

Returns

All products purchased directly from Glendo LLC can be returned for a full refund of their purchase price if received in new condition within 30 days of purchase. All parts, pieces, accessories, manuals, warranty information, and printed materials must be in the original packaging with the product in order to be eligible for a full refund or exchange. Returns after 30 days but within 6 months of purchase may be charged a 20% restocking fee. Returns after 6 months are generally not accepted. Before shipping any returns, please contact Glendo LLC for a Return Authorization (RA) number, which simplifies this process.

CHECK US OUT ON SOCIAL MEDIA



FULLY-EQUIPPED, STATE-OF-THE-ART CLASSROOM



5
DAY / **40**
HOUR
COURSES

-  **INDIVIDUAL ATTENTION**
SMALL-GROUP ENVIRONMENT
-  **MEET + CONNECT**
WITH OTHER ARTISANS
-  **HANDS-ON**
LEARNING



GRS.com

800-835-3519

900 Overlander Road • P.O. Box 1153

Emporia, Kansas 66801 USA

Call Toll-Free to Order: 800-835-3519

Local/International: 620-343-1084

Fax: 620-343-9640 • hello@grs.com